

**HAUTE VISIBILITÉ**  
*HIGH VISIBILITY*

**#WE ARE SAFETY DESIGNER**



# L'UNION FAIT LA FORCE

→ **STRENGTH THROUGH UNITY**

Acteur majeur du marché des Équipements de Protection Individuelle (E.P.I.) dans le monde, COVERGUARD® conçoit, fabrique et distribue une gamme complète de produits uniques, originaux, confortables et fiables, pour protéger les femmes et les hommes sur leurs lieux de travail.

En 2020, nos 12 marques historiques se sont unifiées sous une marque unique, COVERGUARD®. Nous capitalisons sous cette marque emblématique nos longues années d'expérience à développer des produits qui répondent aux risques de tous les secteurs d'activité.

Plus que jamais, COVERGUARD® s'engage aux côtés de ses clients et de ses partenaires pour que la plus simple des idées, la plus petite des opportunités ou la plus forte des exigences deviennent nos succès de demain.

*As a major stakeholder in the worldwide Personal Protective Equipment (PPE) market, COVERGUARD® designs, manufactures and distributes a comprehensive range of unique, original, comfortable and reliable products to protect women and men in the workplace.*

*In 2020, our 12 historical brands came together under a single one, COVERGUARD®. Under this emblematic brand, we are capitalizing on our many years of experience in developing products that respond to the risks of all activity sectors.*

*Now more than ever, COVERGUARD® is committed to its customers and partners, to ensure that the simplest ideas, the smallest opportunities and the most demanding requirements contribute to our future successes.*

# SOMMAIRE / CONTENTS



**TEMPS FROID /**  
*COLD WEATHER*

**P 25**



**TEMPS PLUVIEUX /**  
*RAINY WEATHER*

**P 61**



**TEMPS CHAUD /**  
*WARM WEATHER*

**P 79**



**VÊTEMENTS DE TRAVAIL /**  
*WORKWEAR*

**P 91**



**EXPERT /**  
*EXPERT*

**P 101**



**VISIBILITÉ MODÉRÉE /**  
*MODERATE VISIBILITY*

**P 109**



**ACCESSOIRES /**  
*ACCESSORIES*

**P 113**

# UNE EXPÉRIENCE DE 85 ANS

→ 85 YEARS OF EXPERIENCE

À la fin des années 30, les premiers gants et tabliers de soudeur sortent de nos ateliers établis Chemin de la Scaronne à Lyon, France. Depuis lors, l'entreprise ne cesse de se développer et l'aventure familiale se transforme en une société internationale qui met sa force logistique au service des distributeurs dans plus de 100 pays.

*At the end of the 30's, the first welding gloves and aprons left our workshops located in Chemin de la Scaronne in Lyon, France. Since then, the company has grown and the family venture has developed into an international company that puts its logistical strength at the service of distributors in more than 100 countries.*



////// EUROCURT IMPACT



////// GALENA

## + UNE PRÉSENCE INTERNATIONALE AN INTERNATIONAL FOOTPRINT

**10** FILIALES  
SUBSIDIARIES

**5K** CLIENTS  
CUSTOMERS

**100** PAYS  
COUNTRIES

**1** USINE EN CHINE  
FACTORY IN CHINA

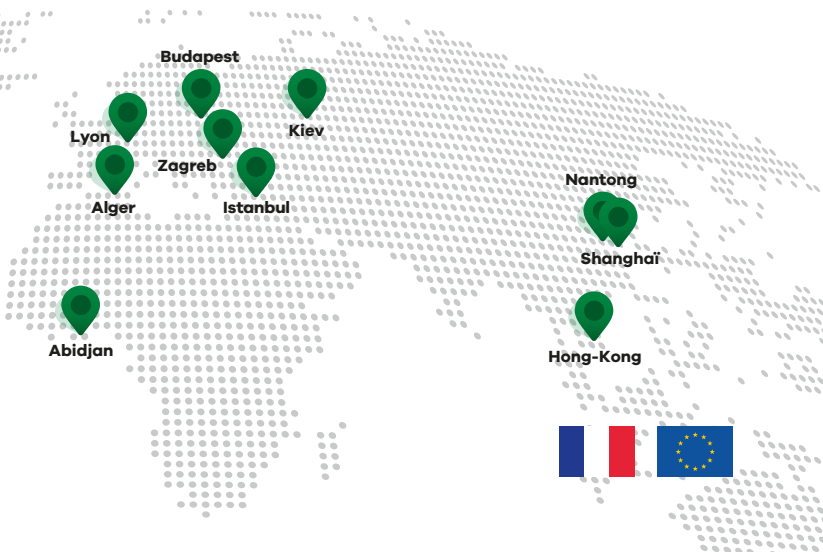

**+ 670**

**COLLABORATEURS**  
*Employees*

**180M**

**D'E.P.I. VENDUS PAR AN**  
*PPEs sold per year*

**905K**

**LIGNES DE COMMANDES PAR AN**  
*Order lines per year*

# NOTRE POLITIQUE POUR LA PLANÈTE

## → OUR CSR POLICY FOR THE PLANET

Notre démarche RSE s'appuie sur 4 grands piliers regroupant 10 engagements. Nos engagements sont animés par plusieurs actions suivies et engagées au quotidien.

*Our CSR effort is supported by four major pillars which bring together 10 commitments. Our commitments are reflected in several types of action that are monitored and applied routinely.*



### PILIER 1 / PILLAR 1

#### Agir sur notre empreinte environnemental *Reducing our environmental footprint*

Être un acteur de la préservation de l'environnement.  
*Contributing to environment protection.*

- 1 Mesurer notre Bilan Carbone et repenser nos actions afin de diminuer notre impact environnemental  
*Measuring our carbon footprint and redesigning our action in order to reduce our environmental impact*
- 2 Optimiser et contrôler notre gestion des déchets  
*Optimising and controlling waste management*



### PILIER 2 / PILLAR 2

#### Agir comme fournisseur responsable *Being a responsible supplier*

Garantir à nos clients des produits de qualité tout en s'assurant que nos activités soient menées dans le respect des droits éthiques et sociaux.

*Giving our customers the guarantee of high-quality products, at the same time making sure that our activities are carried out in line with ethics and social rights.*

- 3 Garantir à nos clients des produits de qualité  
*Giving customers the guarantee of high-quality products*
- 4 Assurer des relations de confiance avec nos fournisseurs  
*Setting up relationships of trust with our suppliers*
- 5 Proposer une offre de produits et de services plus responsables  
*Offering more responsible products and services*



### PILIER 3 / PILLAR 3

#### Agir comme employeur responsable *Being a responsible employer*

Assurer à nos collaborateurs un environnement de travail sécurisé et un parcours professionnel enrichissant dans le respect des règles de non-discrimination, de diversité et d'égalité des chances.

*Providing our employees with a safe working environment and a fulfilling career in accordance with the rules of non-discrimination, diversity and equal opportunity.*

- 6 Déployer des actions pour la sécurité de tous  
*Deploying action to keep everyone safe*
- 7 Promouvoir l'égalité des chances  
*Promoting equal opportunities*



### PILIER 4 / PILLAR 4

#### Agir localement avec nos parties prenantes *Working locally with our stakeholders*

Participer à des actions locales et promouvoir les petits gestes du quotidien auprès de nos équipes.

*Taking part in local action and promoting new habits in our teams.*

- 8 S'engager localement  
*Local commitment*
- 9 Garantir la sécurité des informations  
*Guaranteeing information security*
- 10 Sensibiliser nos collaborateurs aux éco-gestes et consommer localement  
*Making employees aware of environmentally responsible behaviours and consuming locally*

+ 950

CONTAINERS PAR AN  
*Containers per year*

48 M€

DE STOCK  
*of stock*

30K M<sup>2</sup>

DE STOCK  
*of stock*

# WE ARE SAFETY DESIGNER



<p><b>200</b></p> <p><b>NOUVEAUX PRODUITS PAR AN</b></p> <p><i>New products per year</i></p>	<p><b>TAUX DE RÉCLAMATION</b></p> <p><i>Claim rate</i></p> <p><b>0.0028%</b></p>
--	--



**UN NIVEAU DE PERFORMANCE  
ADAPTÉ À CHAQUE BESOIN**  
AN ADAPTED LEVEL OF  
PERFORMANCE FOR EACH NEED

**E  
X  
P  
E  
R  
T**

**Des produits différenciants et dotés  
du meilleur de la technologie et/ou  
du design.**

*Distinctive products with the best of  
technology and/or design.*

**P  
R  
O**

**Des produits avec des performances  
au-delà des exigences attendues  
pour un usage professionnel.**

*Products that perform above and  
beyond the expected requirements  
for professional use.*

**A  
C  
C  
E  
S**

**Des produits qui répondent aux  
exigences d'un usage professionnel à  
prix étudiés.**

*Competitively priced products that  
meet the requirements of professional  
use.*



## Audits éthiques, sociaux et environnementaux

Afin de s'assurer du bon respect de **nos standards éthiques** et sociaux, nous avons élaboré une politique d'audits éthiques de tous nos fournisseurs, avec une fréquence basée sur le volume d'achat ou le score du précédent audit.

Un score est établi sur 100 points. En fonction du volume d'achat et du score obtenu, le fournisseur est **audité** : une fois par an, une fois tous les deux ans ou une fois tous les trois ans si le score optimal est atteint.

### Ethics, social and environmental audits

*In order to ensure compliance with **our ethics and social standards**, we have developed an ethics audit policy for all our suppliers, at a frequency that is based on the purchase volume or the score at the previous audit.*

*A score is given out of 100. Depending on the purchase volume and the score achieved, the supplier is **audited**: once a year, once in every two years or once in every three years if the optimum score is reached.*

**DU VOLUME D'ACHATS EST EFFECTUÉ  
AVEC DES FOURNISSEURS CERTIFIÉS ISO  
14001**

**36%**

**OF PURCHASE VOLUME FROM  
SUPPLIERS WITH ISO 14001  
CERTIFICATION**



## Des programmes de co-développement

Nous mettons en place des programmes de co-développement avec des partenaires industriels et nous investissons également dans des outillages. Nous travaillons en étroite collaboration avec des cabinets de designs industriels et des stylistes pour répondre aux exigences sécuritaires et ergonomiques, tout en prenant soin du look du porteur, même sur son lieu de travail !

Nos produits sont testés et certifiés par des laboratoires mondialement connus (CTC, SATRA, INSPEC, BSI, INTERTEK, SGS, CRITT, ALIENOR, ...).

### Ethics, social and environmental audits

*We are setting up co-development programmes with industrial partners as and we also invest in tooling. We work closely with industrial design firms and stylists to answer the needs of safety and ergonomic requirements, while taking into account the look of the end-users, even in their workplace!*

*Our products are tested and certified by worldrenowned laboratories (CTC, SATRA, INSPEC, BSI, INTERTEK, SGS, CRITT, ALIENOR, ...).*



**Pour proposer des produits qui répondent parfaitement aux besoins des utilisateurs, COVERGUARD® s'appuie sur une équipe d'experts métiers (produit, design, qualité, professions médicales...) interne et externe.**

*To offer products that perfectly meet our users' needs, COVERGUARD® relies on a team of internal and external experts, specialized in the fields of product development, design, quality and medical.*



**Conception,  
Chefs  
de produits**  
*Conception,  
Product  
Managers*



**Design &  
Modélisation**  
*Design &  
Modeling*



**Tests de  
performance  
en laboratoires  
certifiés**  
*Laboratory  
performance  
tests*



**Expertise  
médicale**  
*Medical  
expertise*



**Conception,  
Chefs  
de produits**  
*Conception,  
Product  
Managers*



# CREATED FOR SECURITY, COMFORT & DESIGN

IMPERMÉABLE  
/ WATERPROOF



RIPSTOP  
/ RIPSTOP

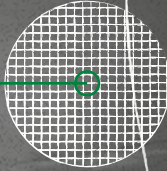

ROBUSTE  
/ RESISTANT



HAUTE VISIBILITÉ  
/ HIGH VISIBILITY



REHAUSSE DOS  
/ RAISED BACK

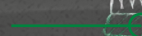

ZONE DE STRETCH  
/ STRETCH AREAS

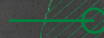

« L'homme et sa sécurité doivent constituer la première préoccupation de toute aventure technologique »  
"Man and his security must be the first concern of any technological adventure"

Albert Einstein

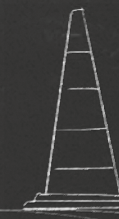





**PROTECTION THERMIQUE**  
/ THERMAL PROTECTION

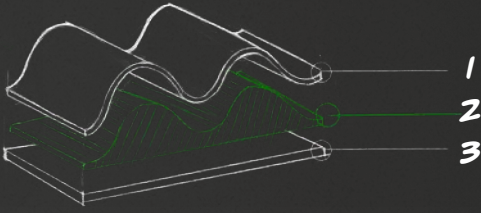

1. **ARMURE MICRO-RIPSTOP**  
/ MICRO-RIPSTOP WEAVE
2. **MATELASSAGE TECHNOLOGIE ECO-FRIENDLY**  
/ BIO-BASED TECHNOLOGY GUILTING
3. **DOUBLURE : TAFFETAS**  
/ LINING : TAFFETA

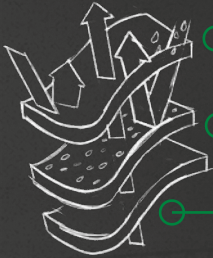

**EXTÉRIEUR**  
/ OUTER LAYER

**MEMBRANE**  
/ MEMBRANE

**DOUBLURE MICROMINK**  
/ MICROMINK LINING

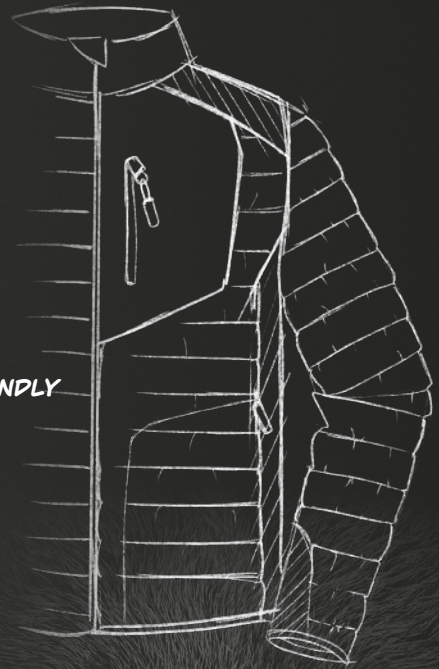

**WE ARE**  
**SAFETY DESIGNER**

Maîtrise de la forme, choix des matières, réalisation de tests (laboratoire et terrain) : nos engagements pour assurer une réponse adaptée aux problématiques liées à différents métiers.

Control of the form, choice of material, realization of tests: here is our commitment to ensure an appropriate response to the issues related to different type of work.

# TEXTILES



## LES FIBRES / FIBRES

Pour qu'une matière soit textile, il faut qu'elle permette notamment la réalisation de fils.

Les fibres textiles entrant dans la composition des vêtements des gammes **Coverguard®** se classent en deux catégories :

**1 - Les Fibres Naturelles** d'origine végétale comme le **Coton**.

**2 - Les Fibres Synthétiques** créées chimiquement comme le **Polyester**, le **Polyamide**, l'**Acrylique** ou l'**Elasthane**.

*For a material to be textile, it must allow the realization of yarns.*

*The textile fibres used in the composition of the clothes of the **Coverguard®** range fall into two categories:*

***1 - Natural Fibres** of plant origin such as **Cotton**.*

***2 - Synthetic Fibres**, or chemically created non-cellulose polymers such as **Polyester**, **Polyamide**, **Acrylic** or **Elastane***



### COTON / COTTON

#### AVANTAGES

- + Doux
- + Très absorbant
- + Lavable à haute température
- + Confortable
- + Éloigne l'électricité statique

#### BENEFITS

- + Soft
- + Highly absorbent
- + Washable at high temperature
- + Comfortable
- + Removes static electricity



### POLYESTER / POLYESTER

#### AVANTAGES

- + Peu froissable / Entretien facile
- + Séchage rapide
- + Bonne stabilité dimensionnelle
- + Forte résistance à l'abrasion
- + Bonne élasticité

#### BENEFITS

- + Low crease / Easy maintenance
- + Quick drying
- + Good dimensional stability
- + Highly abrasion resistant
- + Good elasticity

#### INCONVÉNIENTS

- Conservation moyenne de la chaleur
- Faible résistance à l'abrasion
- Froissable

#### DISADVANTAGES

- Average heat conservation
- Low abrasion resistance
- Wrinkle

#### INCONVÉNIENTS

- Toucher rêche
- Retient la graisse
- Absorbe peu l'humidité

#### DISADVANTAGES

- Rough touch
- Retains oil
- Low moisture absorption



## LES TISSUS / FABRICS



### CHAÎNE ET TRAME / WOVEN

#### OXFORD OXFORD



Tissu avec un aspect de tressage carré obtenu à partir de fils de chaînes et de trames doublés.

*Fabric with a square braided appearance obtained from double warp and weft threads.*

#### RIPSTOP RIPSTOP

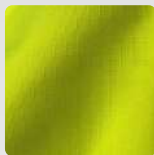

Tissu (issu de l'armure toile) renforcé par une fibre complémentaire lui donnant sa structure en damier et lui permettant d'éviter les déchirures.

*Fabric (from plain weave) reinforced with a complementary fibre giving it its checkered structure and allowing it to avoid tearing.*

#### TAFFETAS TAFFETA

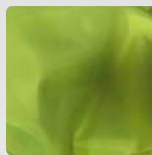

Tissu (issu de l'armure toile) uni et lisse sur les deux faces. Souvent avec un éclat sur sa surface.

*Fabric (from plain weave) plain and smooth on both sides, often bright on its surface.*

#### MATELASSAGE QUILTED

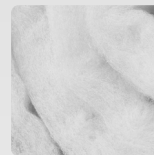

Matelas de Ouatine (rembourrage) entre 2 matières. On peut lui donner du relief à l'assemblage (ex : carrés ou lignes).

*Wadding mattress (padding) between 2 materials. It can be given a relief effect during assembly (e.g. squares or lines).*

#### SERGÉ Twill



L'armure sergé donne un effet de diagonale. Elle possède un endroit/un envers. Elle est plus souple que l'armure toile et résistante à l'usure.

*The twill weave gives a diagonal effect. It has a front/back. It is softer than plain weave and wear resistant.*

# TEXTILES

## MAILLE / KNITWEAR

### JERSEY JERSEY

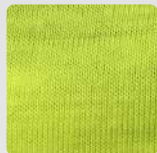

Maille légère et souple. Les deux faces de ce tissu ont un aspect différent. Utilisé dans la fabrication des T-shirts et des polos.

*Light and flexible knit. The two sides of this fabric have a different appearance. Used in the manufacture of T-shirts and polo shirt.*

### CÔTE RIB

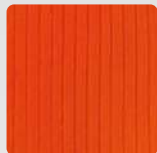

Tissu extensible composé de mailles à l'endroit et à l'envers en alternance. Avec un effet rainure plus ou moins large.

*Stretch fabric composed of alternating face and back stitches. With a more or less wide ribbed effect.*

### BIRD-EYE BIRD-EYE



Maille avec un motif de petits losanges, chacun ayant un point au centre. Il est doux et absorbant.

*A fabric with a pattern of small diamonds, each having a dot in the center. It's soft and absorbent.*

### MOLLETON FLEECE

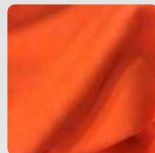

Tissu moelleux et chaud. Il est construit sur une base jersey et gratté à l'intérieur pour lui conférer son aspect duveteux.

*Soft and warm fabric. It's built on a jersey backing and brushed on the inside to give it its fluffy feel.*

### POLAIRE POLAR FLEECE

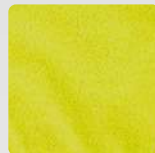

Maille grattée constituée de fibres textiles synthétiques avec un pouvoir isolant, résistant et « déperlant ». On lui attribue certaines qualités communes à la laine mais en plus léger.

*A brushed stitch made of synthetic textile fibres with insulating, resistant and "water-repellent" properties. It is attributed certain qualities, similar to wool although lighter.*

### MAILLE FILET MESH

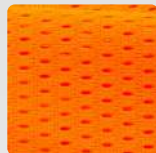

Type de tissu caractérisé par son aspect ouvert en forme de filet et par les espaces entre les fils pour une meilleure respirabilité.

*A type of fabric characterized by its net-like open appearance and the spaces between the yarns for a better breathability.*



## ENDUCTION / COATING



### QU'EST-CE QUE L'ENDUCTION ?

L'enduction est un procédé de **dépose d'un enduit** (matériau plastique) en surface d'un tissu pour lui attribuer des caractéristiques qui ne lui sont pas intrinsèques.

- On parle de **couche d'enduction**
- Elle a un **rôle barrière**

#### Caractéristiques :

- Fixe les fibres : plus grande résistance à l'abrasion et au vieillissement
- Permet la déperlance, l'étanchéité
- Protection contre les intempéries
- Isolation thermique : chaud ou froid

#### Types d'enduit :

PVC :  Souplesse, résistance aux UV /  Effet plus plastique  
PU :  Bonne résistance à la traction et déchirure /  Plus chère

### WHAT IS COATING?

Coating is a process of **applying a coating** (plastic material) to the surface of a fabric to give it characteristics that are not intrinsic to it.

- It is called a **coating layer**
- It has a **barrier role**

#### Characteristics:

- Fixes the fibres: greater resistance to abrasion and ageing
- Allows for water repellency, waterproofing, etc.
- Weather protection
- Thermal insulation: hot or cold

#### Types of coating:

PVC:  Flexibility, UV resistance /  More plastic effect  
PU:  Good tensile and tear strength /  More expensive

### À NE PAS CONFONDRE AVEC UNE MEMBRANE !

La membrane est un **complexe laminé** qui résulte de l'assemblage d'un film et d'un textile par adhésion (thermique). Elle est **imper-respirante** laissant passer l'eau sous forme de vapeur mais bloque les gouttes.

#### NOT TO BE CONFUSED WITH A MEMBRANE!

The membrane is a **complex laminate** that is the result of the assembly of a film and a textile by (thermal) adhesion. It is **waterproof and breathable**, allowing water to pass through in the form of vapour but blocking the drops.



GAMME / RANGE

**SORONA®**



## SORONA®, UNE ALTERNATIVE DE CHOIX AU DUVET SORONA®, A CHOICE ALTERNATIVE TO DUVET

DuPont™ Sorona® est un produit innovant, fait en partie de fibres polyester issues de matières renouvelables.

Cette technologie est choisie pour créer des produits isolants performants et de longue durée.

DuPont™ Sorona® is an innovative product, partly made of polyester fibers derived from renewable materials.

This technology is chosen to create high-performance, long-lasting insulation products.

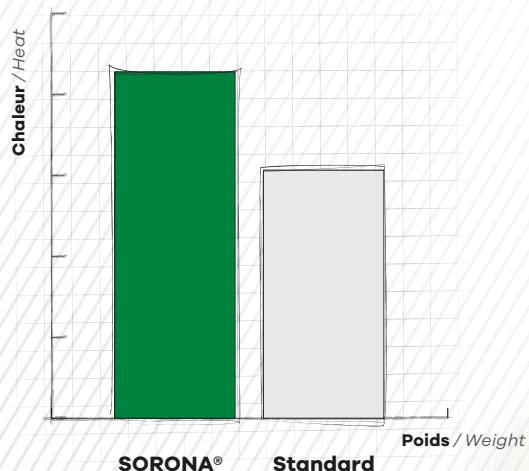

### Meilleure préservation de la chaleur en atmosphère sèche et humide

Better preservation of heat in dry and humid atmospheres:

- +7% d'optimisation du rapport poids/chaleur
- Respirant
- Isolant
- +7% optimization of the weight/warmth ratio
- Breathable
- Insulating



### — Respectueux / Respectful

- En partie issue de matière végétale
- Réduit son impact sur l'environnement: programme de certification Sorona® Common Thread Fabric
- Partly made from plant material
- Reduces its impact on the environment: Sorona® Common Thread Fabric certification program

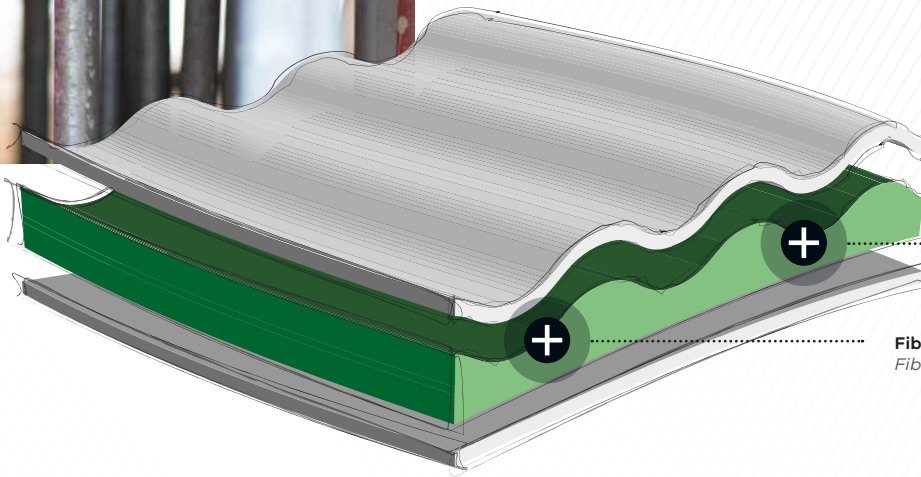

Plus léger, plus chaud  
Lighter, warmer

Fibre en partie d'origine végétale  
Fiber partly bio-based



### — Meilleur remplissage : +36%

*Better filling: +36%*

- Moins de matière pour procurer la même chaleur
- Conserve son volume lavage après lavage
- Meilleure taux de compression : +8%
- Plus de souplesse dans les mouvements
- Less material to provide the same warmth
- Retains its volume wash after wash
- Better compression rate: +8%
- More flexibility in movements



# TEXTILES



## SOFTSHELL / SOFTSHELL

Une Softshell a pour objectif de trouver un **équilibre entre la respirabilité et une imperméabilité** face aux faibles intempéries.

### 3 types de Softshell :

- 1 3 couches : 1 couche extérieure + 1 membrane laminée imperméable et respirante + 1 couche intérieure laminée polaire pour l'apport de chaleur  
Ex : Environnement frais
- 2 2,5 couches : 1 couche extérieure + 1 membrane imperméable et respirante laminée + 1 film protecteur de la membrane  
Ex : Environnement chaud/ mi-saison
- 3 2 couches : 1 couche extérieure + 1 membrane imperméable et respirante laminée + 1 doublure suspendue pour le confort (mesh)  
Ex : Environnement chaud/ mi-saison

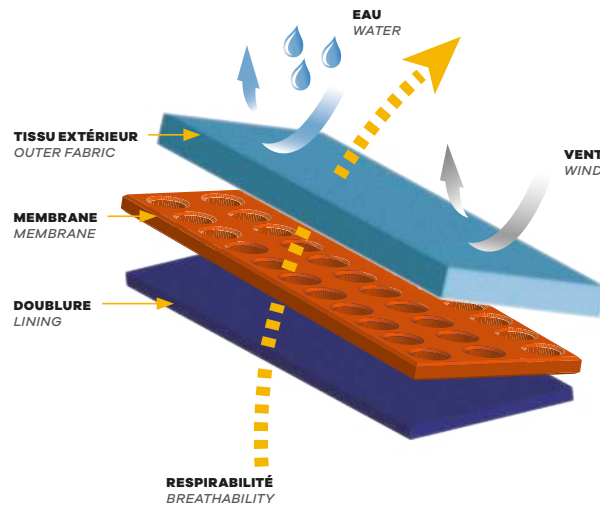

A softshell is designed to **balance breathability and waterproofing** against the elements.

### 3 types of Softshell:

- 1 3 layers: 1 outer layer + 1 waterproof and breathable laminated membrane + 1 inner layer laminated with fleece for warmth.  
E.g. Fresh environment
- 2 2.5 layers: 1 outer layer + 1 waterproof and breathable laminated membrane + 1 protective film of the membrane  
E.g.: Warm environment/ mid-season
- 3 2 layers: 1 outer layer + 1 waterproof and breathable laminated membrane + 1 suspended lining for comfort (mesh)  
E.g.: Warm environment/ mid-season

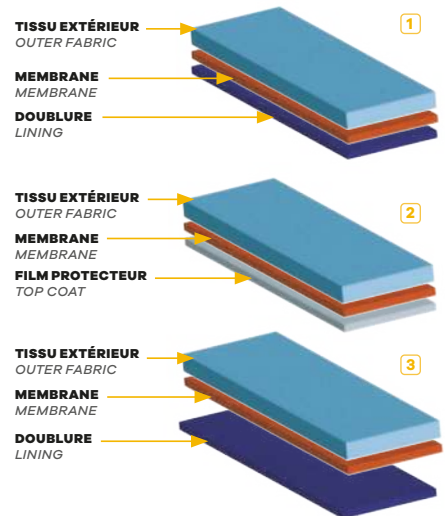

## CONSEILS D'ENTRETIEN / CARE INSTRUCTIONS

Les produits Coverguard® sont pour la majorité tous **compatibles au lavage ménager**. Voici quelques règles à respecter pour prolonger la vie de vos produits :



- Suivre les instructions de lavages inscrites sur l'étiquette
- Fermer les zips, les scratchs et les boutons avant le passage en machine (Évite une usure précoce)
- Proscrire les lessives avec des agents blanchissants
- Éviter les assouplissants sur les produits techniques (peut détériorer les propriétés du tissu : la déperlance, la respirabilité)
- Il est préférable d'éviter le séchage en machine (Peut provoquer rétrécissement & usure précoce)

Most Coverguard® products are **compatible with house cleaning**. Here are some rules to follow to extend the life of your products:



- Follow the washing instructions on the label
- Close zips, velcro and buttons before going into the machine (Prevents premature wear and tear)
- Prohibit laundry detergents with bleaching agents
- Avoid fabric softeners on technical products (Slightly deteriorate the properties of the fabric: water repellency, breathability)
- It is better to avoid machine drying (Can cause shrinkage & early wear)



Ce symbole représente la compatibilité de l'entretien du vêtement en blanchisserie industrielle.  
This symbol means that the garment can be cared for in an industrial laundry.

# SYSTÈME 3 COUCHES / 3 LAYERS SYSTEM

Le **système de couches** ou « **layering** » est une technique qui désigne la superposition de plusieurs couches de vêtements. Chaque couche doit permettre d'évacuer la transpiration vers la couche suivante ou vers l'extérieur.

**1 2 3 : S'habiller c'est aussi simple que de compter :**

- 1** pour rester au sec
- 2** pour conserver la chaleur
- 3** pour se protéger des éléments extérieurs

**Layering** is a technique that refers several layers of clothing. Each layer must allow perspiration to be evacuated to the next layer or to the outside.

**1 2 3 : Dressing is as simple as counting :**

- 1** to stay dry
- 2** to keep warm
- 3** to be protected against external elements

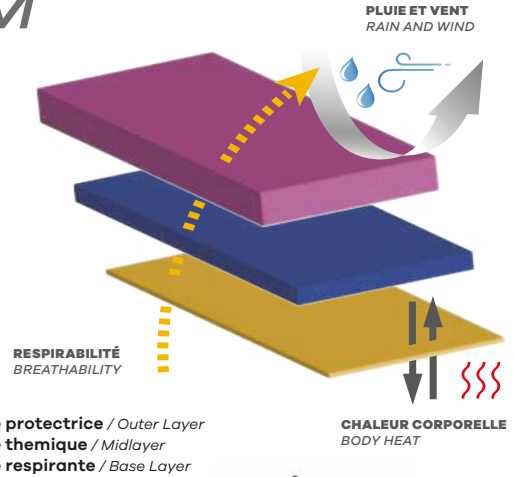

## COUCHE DE BASE : CONTACT DIRECT AVEC LA PEAU

### BASE LAYER : DIRECT SKIN CONTACT

**But :** Garder la peau au sec.

Une bonne couche de base doit :

- absorber l'humidité
- évacuer la transpiration rapidement
- sécher rapidement

**Aim:** To keep the skin dry.

A good base layer must:

- feature moisture absorption
- evacuate perspiration quickly
- dry quickly

**Les produits :**

Sous-vêtements / T-shirts

**The products:**

Underwear / T-shirts



## COUCHE INTERMÉDIAIRE : COUCHE D'ISOLATION ET DE CHALEUR

### MIDLAYER: INSULATION AND HEAT LAYER

**But :** Maintenir le corps au chaud.

Une bonne couche intermédiaire doit :

- tenir chaud
- transférer l'humidité
- sécher rapidement
- conserver ses propriétés même humide

**Aim:** To keep the body warm.

A good intermediate layer must:

- keep warm
- transfer moisture
- dry quickly
- preserve its properties even when wet

**Les + :**

- Possibilité de cumuler les couches intermédiaires
- La couche 2 en hiver peut devenir la couche extérieure en été

**The + :**

- Possibility to combine intermediate layers
- Winter layer 2 can become an outer layer in summer

**Les produits :**

Molleton / Polaire / Softshell / Vestes matelassées légères / Gilets

**The products:**

Fleece / Softshell / Lightweight padded jacket / Vests



## COUCHE EXTÉRIEURE : BOUCLIER AVEC L'EXTÉRIEUR

### OUTER LAYER : SHIELD WITH OUTSIDE

**But :** Protéger des aléas climatiques

Une bonne couche extérieure doit :

- évacuer l'humidité intérieure : respirante
- être imperméable
- être coupe vent

**Aim:** Protect from climatic hazards

A good outer layer must:

- wick away indoor humidity: breathable
- be waterproof
- be wind breaker

**Les produits :**

Blousons / Parkas / Rainwear

**The products:**

Jackets / Parkas / Rainwear



## AVANTAGES / BENEFITS

### LOOK

Jeu de matières/couleurs  
Combinations of fabrics/  
colors

### THERMIQUE THERMAL

### MODULABLE ADAPTABLE

selon l'environnement et l'effort  
depending on the environment  
and effort

### CONFORT COMFORT



# NORMES / STANDARDS

## EN ISO 13688

### VÊTEMENTS DE PROTECTION : EXIGENCES GÉNÉRALES

#### PROTECTIVE CLOTHING : GENERAL REQUIREMENTS

Cette norme permet de répondre aux exigences essentielles du règlement : *This standard fulfils the essential requirements of the regulation :*

- L'ergonomie
- Le confort
- L'innocuité
- La compatibilité des vêtements avec d'autres équipements ou portés ensemble
- La durabilité, le vieillissement
- Le marquage et la notice d'information
- Indication de la taille du porteur
- Ergonomics
- Comfort
- Innocuousness
- Compatibility of the garments with other equipment or worn as a set
- Durability, ageing
- Marking and information notice
- Indication of the wearer's size

**Elle ne peut pas être utilisée seule mais uniquement en association avec d'autres normes.** *It cannot be used alone but only in association with other standards.*

Elle ne permet pas de qualifier une protection.

*It does not qualify as protection.*



## EN 14404 + A1

### RELATIF À LA PROTECTION DES GENOUX

#### RELATING ON KNEE PROTECTION

Cette norme spécifie les exigences relatives aux protections des genoux. Elle décrit les méthodes d'essais et définit les niveaux de performances. La position à genoux peut engendrer des douleurs et/ou des blessures ; **les genouillères servent à protéger les genoux de l'utilisateur et lui apporter le confort nécessaire** dans le cadre de son activité. Elles doivent aussi permettre la répartition de la force.

#### 4 types de protections :

- **Type 1** : protections des genoux indépendantes d'un autre vêtement et attachées autour de la jambe
- **Type 2** : mousse insérée dans des poches sur les jambes de pantalon (ou fixe)
- **Type 3** : dispositifs non fixés au corps mais mis en place lors du déplacement de l'utilisateur (pour chaque genou ou pour les deux genoux ensemble)
- **Type 4** : dispositif avec des fonctions supplémentaires, tel qu'un cadre aidant à se relever ou un agenouilleur

#### 3 niveaux de protections :

- **Niveau 0** : sols plats - pas de résistance à la pénétration exigée
- **Niveau 1** : sols plats - résistance à la pénétration exigée d'au moins 100N
- **Niveau 2** : conditions difficiles - résistance à la pénétration exigée d'au moins 250N

*This standard specifies the requirements for knee protection. It describes the test methods and defines the levels of performance. The kneeling position can cause pain and/or injury ; **knee pads are used to protect the user's knees and provide the necessary comfort** in the context of his activity. They must also allow the distribution of force.*

#### 4 types of protections :

- **Type 1**: knee protectors independent of another garment and attached around the leg.
- **Type 2**: foam inserted in pockets on pant legs (or fixed)
- **Type 3**: devices not fixed to the body but fitted when the user moves (for each knee or for both knees together)
- **Type 4**: device with additional functions, such as a standing frame or kneeling device

#### 3 levels of protection :

- **Level 0**: flat floors - no penetration resistance required
- **Level 1**: flat floors - required penetration resistance of at least 100N
- **Level 2**: difficult conditions - required penetration resistance of at least 250N





# NORMES / STANDARDS



**NF EN 343+A1 : 2019**

**PROTECTION CONTRE LA PLUIE**

**PROTECTION AGAINST RAIN**

La norme **NF EN 343+A1** spécifie les exigences et les méthodes d'essais applicables aux matériaux et aux coutures des vêtements de protection contre les **intempéries**, telles que la précipitation sous forme de **pluie** ou de **neige**, le **brouillard** et l'**humidité du sol**.

La norme distingue deux caractéristiques essentielles :



**La résistance à la pénétration de l'eau ou étanchéité**, également mesurée pour les coutures. Plus la classe (1 à 4) est élevée, plus le vêtement est imperméable.



**La résistance à la vapeur d'eau ou respirabilité**, permettant d'évaluer la perméabilité d'un textile à la vapeur d'eau, c'est-à-dire sa capacité à évacuer la transpiration. Plus la classe (1 à 4) est élevée, plus celui-ci est résistant.



**Vêtement prêt à porter contrôlé sous simulateur de pluie**  
R sera remplacé par x si le vêtement n'a pas été soumis à l'essai

Sur l'ancienne version de la norme NF EN 343: 2007, les niveaux des classes étaient de 1 à 3

Standard **NF EN 343+A1** specifies the requirements and test methods applicable to the materials and seams of protective clothing against severe weather, such as precipitation in the form of **rain** or **snow**, **fog** and **ground moisture**.

The standard distinguishes two essential characteristics:



**Resistance to the penetration of water or sealing**, also measured for seams. The higher the class (1 to 4), the more waterproof the garment.



**Resistance to water vapour or breathability**, to evaluate the permeability of a textile to water vapour, i.e. its ability to evacuate perspiration. The higher the class (1 to 4), the more breathable it is.



**Ready-to-wear garment tested under rain simulator**  
R will be replaced by x if the garment has not been tested

On the old version of the standard NF EN 343: 2007, the levels of the classes were from 1 to 3.



# NORMES / STANDARDS



## EN ISO 20471

### VÊTEMENTS À HAUTE VISIBILITÉ HIGH-VISIBILITY CLOTHING

La norme **EN ISO 20471** spécifie les exigences que doivent respecter les vêtements à **Haute Visibilité** afin de signaler visuellement la présence de l'utilisateur, notamment dans des conditions dangereuses, **de jour comme de nuit**.

Beaucoup de professionnels peuvent être concernés par le port de vêtements haute visibilité.

L'usage de vêtements de signalisation normés EN ISO 20471 est :  
- **obligatoire** selon des conditions de travail du porteur (ex : aux abords d'axes routiers, dans les différents types de transport (routier, ferroviaire), sur piste d'aéroport)

- **fortement recommandé** (ex : sur les chantiers, caristes)

**Le tissu fluorescent** : permet la visibilité de jour. Il réagit sous les rayonnements de la lumière naturelle et transforme une partie de la lumière non visible (UV) en lumière visible.

**3 coloris homologués** : jaune, orange et rouge créant un contraste avec l'environnement naturel.

**La matière rétro-réfléchissante** : permet la visibilité de nuit. Elle renvoie un maximum de lumière vers sa source (phares des véhicules)

La norme distingue **3 classes (X)** :

Selon les surfaces minimales des matières **fluorescentes et rétro-réfléchissantes** pour les 3 classes, plus les **matières à caractéristiques combinées** (uniquement pour la classe 1)

The **EN ISO 20471** standard specifies the requirements that **High Visibility** garments must comply with in order to visually signal the presence of the user, particularly in conditions of dangerous, **day and night**.

Many professionals may be concerned about wearing high-visibility clothing.

The use of signal clothing conforming to EN ISO 20471 is:  
- **compulsory** according to the wearer's working conditions (e.g. on roadsides, in different types of transport (road, rail), on airport runways)

- **highly recommended** (e.g. on building sites, forklift operators)

**Fluorescent fabric**: allows daytime visibility. It reacts under the radiation of natural light and transforms part of the non-visible light (UV) into visible light.

**3 approved colours**: yellow, orange and red, creating a contrast with the natural environment.

**Retro-reflective material**: allows visibility at night. It reflects a maximum amount of light back to its source (vehicle headlights)

The standard distinguishes between **3 classes (X)**:

Depending on the minimum surface areas of **fluorescent and retro-reflective** materials for the 3 classes, plus **materials with combined characteristics** (only for class 1)



Selon les surfaces minimales des matières **fluorescentes et rétro-réfléchissantes**, la norme distingue **trois classes (X)** :

Depending on the minimum surface areas of **fluorescent and retro-reflective** materials the standard distinguishes between **three classes (X)** :

#### Classe 1 / Class 1

#### Classe 2 / Class 2

#### Classe 3 / Class 3

Niveau de visibilité le **plus faible**  
**Lowest level of visibility**

Niveau de visibilité **intermédiaire**  
**Intermediate level of visibility**

Niveau de visibilité le **plus élevé**  
**Highest level of visibility**

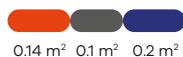

● Fluorescent  
Fluorescent

● Matière rétro-réfléchissantes  
Retro-reflective material

● Matière à caractéristiques combinées  
Material with combined characteristics

# NORMES / STANDARDS



**EN 17353 : 2020**

## ÉQUIPEMENT DE VISUALISATION AMÉLIORÉE POUR DES SITUATIONS À RISQUE MODÉRÉ

ENHANCED VISIBILITY EQUIPMENT FOR MEDIUM RISK SITUATIONS

La norme **EN 17353** spécifie les exigences que doivent respecter les **équipements de visualisation améliorés** afin de rendre plus perceptible la présence de l'utilisateur, notamment dans des situations de risque modéré à la lumière/l'éclairage **de jour** comme de **nuit**.

The **EN 17353** standard specifies the requirements for **enhanced visualization** equipment to make the user's presence more perceptible, especially in situations of moderate light/lighting risk, both **day** and **night**.



**Type A** : Équipements pour la lumière du jour  
→ utilisation de matière fluorescente uniquement

**Type A**: Equipment for daylight  
→ use of fluorescent material only



**Type B** : Équipements pour l'obscurité  
→ utilisation de matière rétro réfléchissante uniquement

**Type B**: Equipment for dark conditions  
→ use of retroreflective material only



**Type AB** : Équipement pour la lumière du jour et l'obscurité  
→ utilisation de matière fluorescente, rétro réfléchissante et/ou de matière à caractéristiques combinées

**Type AB**: Equipment for daylight and dark conditions  
→ use of fluorescent, retroreflective and/or combination material

TYPE / TYPE	A	B1	B2	B3	AB
<b>STATURE DE L'UTILISATEUR SI :</b> USER'S STATURE IF	≥ 140cm				
<b>MATIÈRE FLUORESCENTE</b> FLUORESCENT MATERIAL	0,24 m <sup>2</sup>	-	-	-	0,24 m <sup>2</sup>
<b>MATIÈRE RÉTRO RÉFLÉCHISSANTE</b> RETROREFLECTIVE MATERIAL	-	0,003 m <sup>2</sup>	0,018 m <sup>2</sup>	0,08 m <sup>2</sup>	0,08 m <sup>2</sup>
<b>MATIÈRE À CARACTÉRISTIQUES COMBINÉES</b> MATERIAL WITH COMBINED CHARACTERISTICS	-	-	-	-	0,24 m <sup>2</sup>



# NORMES / STANDARDS



## NF EN 14058 : 2017

### PROTECTION CONTRE LES ENVIRONNEMENTS FRAIS PROTECTION AGAINST COOL ENVIRONMENTS

La norme **NF EN 14058** spécifie les exigences et les méthodes d'essais relatives aux performances des vêtements de protection contre les environnements modérément froids. Un climat frais est l'alliance entre des conditions d'humidité et de vent à une température d'air de  $-5^{\circ}\text{C}$  et plus.

La norme EN 14058 prend en compte plusieurs types d'indices de performance :



**A : Classe de la résistance thermique  $R_{ct}$  :** mesurée sur l'ensemble des couches du produit. Mesure le pouvoir isolant d'un vêtement (4 classes)

**B : Classe de la perméabilité à l'air (AP) :** mesurée sur l'ensemble des couches du produit (3 classes)

**C : Icier**, en  $\text{m}^2\text{K}/\text{W}$ , du vêtement avec l'ensemble des vêtements standards R est obligatoire pour une  $R_{ct}$  de classe 4, facultative pour les classes 1 à 3.

**WP :** Résistance à la **pénétration d'eau** (facultatif)

Standard **NF EN 14058** specifies the requirements and test methods relating to the performance of protective clothing against moderately cold environments. A cool climate is the combination of humid and windy conditions at an air temperature of  $-5^{\circ}\text{C}$  and above.

The EN 14058 standard takes into account several types of performance indices:

**A: Thermal resistance class  $R_{ct}$ :** measured over the entire fabric layer. Measures the insulating capacity of a garment (4 classes)

**B: Air permeability class (AP):** measured over all layers of fabric (3 classes)

**C: Icier**, in  $\text{m}^2\text{K}/\text{W}$ , clothing with all standard R clothing is compulsory for a class 4  $R_{ct}$ , optional for classes 1 to 3.

**WP:** Resistance to water penetration (optional).

RÉSISTANCE THERMIQUE ( $\text{M}^2\text{K}/\text{W}$ ) THERMAL RESISTANCE ( $\text{M}^2\text{K}/\text{W}$ )	CLASSE CLASS
$0,06 \leq R_{CT} < 0,12$	1
$0,12 \leq R_{CT} < 0,18$	2
$0,18 \leq R_{CT} < 0,25$	3
$0,25 \leq R_{CT}$	4

PERMÉABILITÉ À L'AIR (MM/S) AIR PERMEABILITY (MM/S)	CLASSE CLASS
$100 < AP$	1
$5 < AP < 100$	2
$AP \leq 5$	3



# NORMES / STANDARDS



**NF EN 342 : 2017**

## VÊTEMENTS DE PROTECTION CONTRE LE FROID GARMENTS FOR PROTECTION AGAINST COLD

La norme **NF EN 342** spécifie les exigences et les méthodes d'essais relatives aux performances des vêtements de protection contre les effets d'environnements froids à des températures inférieures à **-5°C**, mixant également vent et humidité.

La norme distingue trois caractéristiques essentielles

The **NF EN 342 standard** specifies the requirements and test methods on the performance of protective clothing against the effects of cold environments at **temperatures below -5°C**, also mixing wind and humidity.

The standard distinguishes three essential characteristics



**Y : Isolation thermique :** Icler en  $m^2K/W$ , de la tenue complète (3 classes)

**AP : Classe de la perméabilité à l'air (AP) :** mesurée sur l'ensemble des couches du produit (3 classes)

**WP :** Résistance à la **pénétration d'eau** (facultatif)

**Y: Thermal insulation:** Icler in  $m^2K/W$ , of complete outfit (3 classes)

**AP: Air permeability class (AP):** measured over all layers of the product (3 classes)

**WP: Resistance to water penetration** (optional)

# PANORAMA

## → OVERVIEW

### LES COMBINABLES X/1 / THE COMBOS X/1

1 PARKA / PARKA

2 DOUBLURE / LINING

PARKAS MULTI-COUCHES  
PARKA MULTILAYERS

**SANGAKU**

5SAN16 / 5SAN17

p. 65

**KAZAN**

5KAP160 / 5KAP170

p. 66

**KAZAN 2/1**

OU / OR

**KAZAN SOFTSHELL**

**ROADWAY 4/1**

7ROPY / 7ROPO

p. 29

**KANATA**

7KANR / 7KANG / 7KANO / 7KANR / 7KANA

p. 33

PARKAS  
PARKAS

**ROADWAY**

7ROAY / 7ROAO

p. 34

**KETA**

7KETY / 7KETO / 7KETR

p. 35

**NEW**

**SOKOBIE**

5SOK16 / 5SOK17

p. 38

**NEW**

**HORA**

5HOR160 / 5HOR170

p. 40

SOFTSHELL

**KANPA**

5KPA16 / 5KPA17

p. 43

**STATION**

MO70630 / MO70640 / MO70680

p. 44

**KAZAN SOFTSHELL**

5KAS160 / 5KAS170

p. 45

**THERMIQUE / THERMAL**

**KAZAN 2/1**

5KAJ160 / 5KAJ170

p. 46

**HI-WAY 2/1\***

MO70530\*

p. 47

THERMIQUE / THERMAL

**HI-WAY 2/1**

7HWXY / 7HWXO

p. 48

**NEW**

**FLAKE**

5FLA160 / 5FLA170

p. 49

**NEW**

**RITTO**

5RIT160 / 5RIT170

p. 51

**STATION POLAR**

7PSTY / 7PSTO

p. 52

**NEW COLOR**

**GOKKAN**

5GOK16 / 5GOK17 / 5GOK130

p. 53

BLOUSONS  
BOMBERS

**SOUKOU**

5SOU160 / 5SOU170

p. 54

**AIRPORT**

7AIBY / 7AIBO

p. 55

**HI-WAY**

7HWGY / 7HWGO

p. 56

**HI-WAY**

MO70500 / MO70510

p. 57

**YORU**

5YOR160 / 5YOR170

p. 59



























GILETS FROIDS  
BODYWARMERS

TEMPS FROID / COLD WEATHER

VESTES / JACKETS



























# PANORAMA

## → OVERVIEW

TEMPS PLUVIEUX / RAINY WEATHER	VESTE DE PLUIE RAIN JACKET	<b>HOTARU*</b>	<b>SANGAKU</b>	<b>KAZAN</b>	<b>HYDRA</b>	<b>HARBOR*</b>	
							
		5HOT16* / 5HOT17*	5SAN16 / 5SAN17	5KAP160 / 5KAP170	5HYJ16 / 5HYJ17	MO70310* / MO70330*	
		p. 62	p. 65	p. 66	p. 68	p. 70	
		PARKAS PARKAS	<b>KAWA COAT*</b>	<b>HYDRA</b>	<b>HARBOR*</b>	<b>KAWA</b>	<b>HI-WAY</b>
							
	5KWC160* / 5KWC170*		5HYP16 / 5HYP17	MO70320* / MO70340*	5KAW160 / 5KAW170	7HWRY / 7HWRO	7HYDY / 7HYDO
	p. 72		p. 69	p. 71	p. 73	p. 74	p. 77
	TEMPS CHAUD / WARM WEATHER		MANCHES LONGUES LONG SLEEVES	<b>SUNO</b>	<b>RIKKA</b>	<b>YARD*</b>	<b>KYRIO</b>
							
7SUNY / 7SUNO / 7SUNR		5RIK160 / 5RIK170		7YAPY* / 7YAPO*	7KYRY / 7KYRO	7KOMY / 7KOMO / 7KOMR	
p. 80		p. 81		p. 82	p. 84	p. 84	
MANCHES COURTES SHORT SLEEVES		<b>NEKKI</b>		<b>YARD*</b>	<b>YARD</b>	<b>OKI</b>	<b>YARD</b>
							
		5NEK160 / 5NEK170	7YATY* / 7YATO*	7YAVY / 7YAVO	5OKI160 / 5OKI170	MO70270 / MO70280	
		p. 85	p. 86	p. 86	p. 87	p. 87	
		GILETS VESTS	<b>YARD</b>	<b>YARD</b>	<b>NEPPA</b>	<b>YARD</b>	<b>YARD</b>
							
MO70216 / MO70236 / MO70206 / MO70226	MO70212 / MO70232		5NEP16 / 5NEP17	MO70242 / MO70252 / MO70262 / MO70265*	7YGMY / 7YGMO	7KIDY / 7JUNY	
p. 88	p. 88		p. 89	p. 89	p. 90	p. 90	
						ENFANT CHILD	

# PANORAMA

## → OVERVIEW

VÊTEMENTS DE TRAVAIL / WORKWEAR	COTON - POLYESTER COTTON - POLYESTER	245 g/m <sup>2</sup>	<b>PATROL*</b>  7PAJV* / 7PAOV* p. 92		<b>PATROL</b>  7PAJP / 7PAOP p. 93																									
			<b>HIBANA</b>  5HBJ160 / 5HBJ170 / 5HBJ130 p. 96		<b>HIBANA</b>  5HBA16 / 5HBA17 / 5HBA130 p. 97		<b>HIBANA</b>  5HBB160 / 5HBB170 p. 98		<b>HIBANA</b>  5HBS160 / 5HBS170 p. 99																					
MULTIRISQUES MULTIRISKS			<b>THOR</b>  8MTHJY p. 102		<b>THOR</b>  8MTHTY p. 102		<b>THOR</b>  8MTHCY p. 103		<b>NOTT</b>  5NOT16 p. 104		<b>EKHI</b>  5EKH160 p. 106		<b>HODER</b>  5HOD16 / 5HOD17 p. 107																	
			VISIBILITÉ MODÉRÉE MODERATE VISIBILITY		CROSS CATEGORIES CROSS CATEGORIES		<b>VIGILE</b>  5VIG010 p. 110		<b>SECURITE</b>  5SEC010 p. 110		<b>RAINET</b>  5RAI08 / 5RAI12 p. 111		<b>RAINET COAT</b>  5RAC120 p. 111		<b>DAGDA</b>  5DAG12 p. 112		<b>TUISTO</b>  5TUI120 p. 112													
							ACCESSOIRES ACCESSORIES		SIGNALISATION / SIGNAGE		<b>KOUKOU*</b>  5KOU16* p. 114		<b>ARMYARD*</b>  7ARMG* / 7ARMO* / 7ARMY* p. 114		<b>TAPE</b>  70010 p. 115		<b>CONE</b>  70303 p. 115		<b>CONE</b>  70300 p. 115		LAMPES / LAMPS		<b>HEADLIGHT</b>  MO71950 p. 116		<b>HEADLIGHT</b>  MO71920 p. 116		<b>ATEX</b>  MO71900 p. 117		<b>ATEX*</b>  MO71910* p. 117	





# TEMPS FROID

**COLD** WEATHER



# LES COMBINABLES / THE COMBOS

## → LE CONCEPT / THE CONCEPT

Un concept **polyvalent**, offrant une multitude de choix de combinaisons. Il a été pensé pour s'adapter aux conditions saisonnières de l'automne au printemps en offrant une **protection complète pour tous les temps**

A **multi-purpose** concept, offering a multitude of combination options. It has been designed to adapt to seasonal conditions from autumn to spring, offering **complete protection for all weathers**

**Zip compatible entre**  
Zip compatible between

- 1 la coque**  
shell
- 2 la doublure**  
lining



## 1 JE CHOISIS MA PARKA / I CHOOSE MY PARKA

Une **parka extérieure** doublée en mesh pour la circulation de l'air et aux coutures étanchées contre la pluie.

**USAGE** : protection lors de climats doux / pluvieux / venteux - Nécessitant une matière résistante

An **outer parka** with mesh lining for air circulation and taped seams for rain protection.

**USE**: protection in mild / rainy / windy climates - Requires hard woven material



ou / or



**KAZAN** 5KAP160 / 5KAP170  
Parka de pluie HV / HV Rain parka

**SANGAKU** 5SAN16 / 5SAN17  
Parka de pluie Ripstop HV / HV Ripstop Rain parka

## 2 JE CHOISIS MA DOUBLURE / I CHOOSE MY LINING

Une **veste aux manches amovibles** doublée en polaire pour apporter chaleur, confort et fonctionnalité. Ses coutures étanchées lui confère un atout supplémentaire par temps de pluie.

**USAGE** : protection lors de climats frais / sec / peu pluvieux - Nécessitant une matière résistante

A **jacket with removable sleeves** and fleece lining for warmth, comfort and functionality. Its taped seams give it an extra edge in wet weather.

**USE**: protection in cool/dry/lightly rainy climates - Requires a durable material

Une **softshell** pour protéger des faibles intempéries grâce à sa couche extérieure déperlante et sa doublure en polaire. Ses bandes segmentées lui confère une grande flexibilité.

**USAGE** : protection lors de climats frais / sec / humide / venteux - Nécessitant une matière souple et légère

A **softshell** to protect against light weather with its water-repellent outer layer and fleece lining. Its segmented bands give it great flexibility.

**USE**: protection in cool/dry/wet/windy climates - Requires a soft, lightweight material



ou / or



**JACKET** 5KAJ160 / 5KAJ170  
Veste thermique 2/1 / 2/1 thermal jacket

**SOFTSHELL** 5KAS160 / 5KAS170  
Veste Softshell / Softshell jacket

# 3

## J'OBTIENS UNE MULTITUDE DE POSSIBILITÉS I GET A MULTITUDE OF POSSIBILITIES

### LA COMBINAISON

Combinez la parka avec la veste 2/1 ou la veste softshell et découvrez le confort d'un produit qui s'adapte à tous les aléas du climat !

### THE COMBO

Combine the parka with the 2/1 jacket or the softshell jacket and discover the comfort of a product that adapts to all climate hazards!

4→1



### KAZAN + JACKET

Parka de pluie HV + Veste thermique 2/1  
HV Rain parka + 2/1 thermal jacket

3→1



### KAZAN + SOFTSHELL

Parka de pluie HV + Veste softshell  
HV Rain parka + softshell jacket

4→1



### SANGAKU + JACKET

Parka de pluie Ripstop HV + Veste thermique 2/1  
HV Ripstop Rain parka + 2/1 thermal jacket

3→1



### SANGAKU + SOFTSHELL

Parka de pluie Ripstop HV + Veste softshell  
HV Ripstop Rain parka + softshell jacket



PARKA 4/1 / 4/1 PARKA

# ROADWAY 4/1

7ROPY / 7ROPO



7ROPY



7ROPO

## AVANTAGES / BENEFITS

- PROTECTION THERMIQUE: normée pour les climats frais
- RESPIRABILITÉ: maille filet dans la parka
- CONFORT: polaire dans la veste amovible

- THERMAL PROTECTION: standardized for cool climates
- BREATHABILITY: mesh in the parka
- COMFORT: fleece in the removable jacket



EN 20471  
Parka 4/1 /  
4/1 Parka (S)



EN 20471  
Parka 4/1 /  
4/1 Parka (M+)



EN 14058

TAILLES SIZES	M	L	XL	2XL	3XL
JAUNE HV HV YELLOW	7ROPYM	7ROPYL	7ROPYXL	7ROPYXXL	7ROPYXXXL
ORANGE HV HV ORANGE	7ROPOM	7ROPOL	7ROPOXL	7ROPOXXL	7ROPOXXXL
CONDITIONNEMENT PACKAGING	Emballage individuel ou par 10 / Individual pack or per 10				

→ **Parka / Parka****TISSUS / FABRICS**

- OXFORD : 100% Polyester enduit Polyuréthane - 300D
- DOUBLURE MESH : 100% Polyester - 50g/m<sup>2</sup> (corps)
- DOUBLURE TAFFETAS : 100% Polyester - 50g/m<sup>2</sup> (bas + manche)

■ IMPERMÉABILITÉ : 3 000 mm

- BANDES RÉTRO-RÉFLÉCHISSANTES: Bandes cousues microbilles : 5cm

- OXFORD: 100% Polyester, Polyurethane coated - 300D
- MESH LINING : 100% Polyester - 50g/m<sup>2</sup> (body)
- TAFFETA LINING: 100% Polyester - 50g/m<sup>2</sup> (bottom + sleeves)

■ WATERPROOFNESS : 3 000 mm

- RETRO-REFLECTIVE BANDS: sewn microbead bands: 5cm

**CARACTÉRISTIQUES / FEATURES**

- Coutures étanchées
- Capuche fixe intégrée dans le col + Cordon de serrage
- Col montant
- Zip central sous rabat à pressions
- Poignets réglables par scratch
- Taille ajustable par cordon élastique & bloqueurs
- 2 poches basses sous rabat fermé par scratch
- Empiècements contrastés: Bas + Poignets
- Bandes cousues : 2 bretelles + 2 ceintures + 2 brassards/manche
- Trappe de marquage
- Ventilation indirecte sous les empiècements devant et dos
- Cilletts d'aération sous les aisselles
- NB lavages : 20

- Taped seams
- Fixed hood integrated into collar + drawstring
- High collar
- Central zip under snap flap
- Adjustable cuffs by Velcro tab
- Adjustable waistband with elastic drawstring & blockers
- 2 lower pockets under flap closed by velcro
- Contrasting yokes: Bottom + Cuffs
- Sewn bands: 2 straps + 2 belts + 2 armbands/sleeve
- Marking access
- Indirect ventilation under front and back yokes
- Underarm ventilation eyelets
- NB washes: 20

→ **Veste amovible /  
Removable jacket****TISSUS / FABRICS**

- OXFORD : 100% Polyester enduit Polyuréthane - 300D
- BORDS-CÔTES: 100% Polyester
- DOUBLURE POLAIRE: 65% Polyester / 35% coton - 280g/m<sup>2</sup>
- MATELASSAGE : 100% Polyester - 160g/m<sup>2</sup> (manches)
- DOUBLURE TAFFETAS: 100% Polyester - 50g/m<sup>2</sup> (manches)

■ IMPERMÉABILITÉ : 3 000 mm

- BANDES RÉTRO-RÉFLÉCHISSANTES: Bandes cousues microbilles : 5cm

- OXFORD: 100% Polyester, Polyurethane coated - 300D
- RIB: 100% Polyester
- FLEECE LINING: 65% Polyester / 35% Cotton - 280g/m<sup>2</sup> (body)
- PADDING: 100% Polyester - 160g/m<sup>2</sup> (sleeves)
- TAFFETA LINING: 100% Polyester - 50g/m<sup>2</sup> (sleeves)

■ WATERPROOFNESS : 3 000 mm

- RETRO-REFLECTIVE BANDS: sewn microbead bands: 5cm

**CARACTÉRISTIQUES / FEATURES**

- Coutures étanchées
- Col montant
- Zip central
- Manches amovibles
- Poignets coupe-vent en bord-côte
- 2 poches basses sous rabat fermé par scratch
- 1 poche plaquée intérieure fermée par scratch
- Bandes cousues: 2 ceintures + 2 brassards/manche
- Trappe de marquage

- Taped seams
- High collar
- Central zipper
- Removable sleeves
- Ribbed wind cuffs
- 2 lower pockets
- 1 inside patch pocket closed by velcro
- Sewn bands: 2 belts + 2 armbands/sleeve
- Marking access





# KANATA



Capuche retractable  
Storm hood



Manches amovibles  
Removable sleeves

Tissu Oxford enduit  
Oxford coated fabric

Doublure polaire  
fleece lining

Poignets bord-côte  
Ribbed cuff



## ANTI-FROID = SYSTÈME 4-1 ANTI-COLD = 4-1 SYSTEM

- 1** COUCHE PROTECTRICE  
Protège des éléments extérieurs  
Seule = temps doux  
+/ou pluvieux

PROTECTIVE LAYER  
Protects from the elements  
Alone = mild +/or rainy weather

- 2** COUCHE THERMIQUE  
Pour l'apport de chaleur  
Seule = temps frais +  
sec ou humide

THERMAL LAYER  
For the transfer of warmth  
Alone = cool + dry or wet weather

- 1** + **2** Temps froids +/ou pluvieux  
Cold +/or rainy weather

La superposition des couches permet de rester au sec et au chaud. La parka polyvalente est la meilleur solution.

Layering allows you to stay dry and warm.  
The multi-purpose parka is the best solution.



## FOCUS / FOCUS



**POLAIRE = CONFORT & CHALEUR**  
Douce et très bonne barrière au froid avec ses poils qui emprisonnent la chaleur

**FLEECE = COMFORT & WARMTH**  
Soft and very good thermal barrier with its heat trapping hairs



**OXFORD ENDUIT = DÉPERLANCE & RÉSISTANCE**  
Structure de tissage solide + traitement de surface permettant à l'eau de ruisseler

**COATED OXFORD = WATER-REPELLENCE & RESISTANCE**  
Strong weave structure + surface treatment allowing water to run off



PARKA 4/1 / 4/1 PARKA

# KANATA

7KANY / 7KANO / 7KANR / 7KANG / 7KANA



7KANO



7KANY



7KANG



7KANR



7KANA

## AVANTAGES / BENEFITS

- FORTE ISOLATION: Parka + Veste thermique = EN 342
- FORTE IMPERMÉABILITÉ: coutures étanchées + Oxford enduit + EN343 classe 3
- FONCTIONNELLE: Large grille de taille + Possibilité de marquage sur les 2 pièces + manches amovibles

- HIGHLY INSULATED: Parka + Thermal jacket = EN 342
- HIGH WATERPROOFNESS: taped seams + coated Oxford + EN343 class 3
- FUNCTIONAL: Large waist grid + Possibility of marking on the 2 pieces + removable sleeves

TAILLES SIZES	XS	S	M	L	XL	2XL	3XL	4XL	5XL	6XL
ORANGE HV / MARINE HV ORANGE / NAVY BLUE	7KANO XS	7KANO S	7KANO M	7KANO L	7KANO XL	7KANO XXL	7KANO XXXL	7KANO XXXXL	7KANO XXXXXL	7KANO 6XL
JAUNE HV / MARINE HV YELLOW / NAVY BLUE	7KANY XS	7KANY S	7KANY M	7KANY L	7KANY XL	7KANY XXL	7KANY XXXL	7KANY XXXXL	7KANY XXXXXL	7KANY 6XL
JAUNE HV / VERT HV YELLOW / GREEN	-	7KANG S	7KANG M	7KANG L	7KANG XL	7KANG XXL	7KANG XXXL	7KANG XXXXL	-	-
ROUGE HV / MARINE HV RED / NAVY BLUE	-	7KANR S	7KANR M	7KANR L	7KANR XL	7KANR XXL	7KANR XXXL	7KANR XXXXL	-	-
ROUGE HV / ANTHRACITE HV RED / ANTHRACITE	-	7KANA S	7KANA M	7KANA L	7KANA XL	7KANA XXL	-	-	-	-
CONDITIONNEMENT PACKAGING	Emballage individuel ou par 10 / Individual pack or per 10									



EN 343



EN 20471  
Parka 4/1 /  
4/1 Parka



EN 342

0,320m<sup>2</sup>/W (B)  
3 WP

TEMPS FROID / COLD WEATHER



## → Parka / Parka



EN 20471  
Parka /  
Parka

### TISSUS / FABRICS

- OXFORD: 100% Polyester enduit Polyuréthane - 300D
- DOUBLURE TAFFETAS : 100% Polyester - 60g/m<sup>2</sup>
- IMPERMÉABILITÉ : 3 000 mm
- BANDES RÉTRO-RÉFLÉCHISSANTES : Bandes cousues microbilles : 5cm

- OXFORD: 100% Polyester, Polyurethane coated - 300D
- TAFFETA LINING : 100% Polyester - 60g/m<sup>2</sup>
- WATERPROOFNESS : 3 000 mm
- RETRO-REFLECTIVE BANDS: sewn microbead bands: 5cm

### CARACTÉRISTIQUES / FEATURES

- Coutures étanchées
- Capuche fixe intégrée dans le col + Cordon de serrage
- Col montant
- Zip central à double curseur sous rabat à scratchs
- 2 poches basses sous rabat fermé par scratchs
- 1 poche poitrine à soufflet + rabat fermé par scratch
- 1 poche plaquée intérieure fermée par scratch
- 1 poche téléphone intérieure à rabat fermé par scratch
- Empiècements contrastés : Épaules + Bas + Poignets
- Bandes cousues : 2 bretelles + 2 ceintures + 2 brassards/manche
- Trappe de marquage

- Taped seams
- Fixed hood integrated into collar + drawstring
- High collar
- Central zipper with double slider under velcro flap
- 2 lower pockets under flap closed by velcro
- 1 gusseted chest pocket + flap closed by velcro
- 1 inside patch pocket with flap closed by velcro
- 1 inside patch phone pocket with flap closed by velcro
- Contrasting yokes: Shoulders + Bottom + Cuffs
- Sewn bands: 2 straps + 2 belts + 2 armbands/sleeve
- Marking access

## → Veste amovible / Removable jacket



EN 20471  
Gilet froid /  
Bodywarmer

EN 20471  
Veste /  
Jacket

### TISSUS / FABRICS

- OXFORD: 100% Polyester enduit Polyuréthane - 300D
- DOUBLURE POLAIRE: 100% Polyester - 280g/m<sup>2</sup> (Corps)
- MATELASSAGE: 100% Polyester - 120g/m<sup>2</sup> (Manches)
- DOUBLURE TAFFETAS: 100% Polyester - 60g/m<sup>2</sup> (Manches)
- IMPERMÉABILITÉ : 3 000 mm
- BANDES RÉTRO-RÉFLÉCHISSANTES : Bandes cousues microbilles : 5cm

- OXFORD: 100% Polyester, Polyurethane coated - 300D
- FLEECE LINING: 100% Polyester - 280g/m<sup>2</sup> (Body)
- PADDING: 100% Polyester - 120g/m<sup>2</sup> (Sleeves)
- TAFFETA LINING: 100% Polyester - 60g/m<sup>2</sup> (Sleeves)
- WATERPROOFNESS : 3 000 mm
- RETRO-REFLECTIVE BANDS: sewn microbead bands: 5cm

### CARACTÉRISTIQUES / FEATURES

- Coutures étanchées
- Col montant doublé en polaire
- Zip central
- Manches amovibles
- Poignets coupe-vent en bord-côte
- 2 poches basses sous rabat fermé par scratchs
- 1 poche poitrine à soufflet + rabat fermé par scratch
- 1 poche plaquée intérieure fermée par scratch
- Attaches pour fixation à la parka
- Étiquette d'identification
- Protège reins
- Bandes cousues : 2 bretelles + 2 ceintures + 2 brassards/manche
- Trappe de marquage

- Taped seams
- Fleece lined stand-up collar
- Central zipper
- Removable sleeves
- Ribbed wind cuffs
- 2 lower pockets under flap closed by velcro
- 1 gusseted chest pocket + flap closed by velcro
- 1 inside patch pocket closed by velcro
- Loops for attaching to the parka
- Identification label
- Kidney protection
- Sewn bands: 2 straps + 2 belts + 2 armbands/sleeve
- Marking access



PARKA / PARKA

# ROADWAY

7ROAY / 7ROAO



## AVANTAGES / BENEFITS

- ISOLATION: bonne conservation du chaud
- ANTIALISSURE: grands empiècements en coloris foncé sur les zones à risques
- CORPORATE: possibilité de marquage
- INSULATION: good heat retention
- ANTIFOULING: large dark colored inserts on the risk areas
- CORPORATE: possibility of marking



7ROAY



7ROAO

## TISSUS / FABRICS

- OXFORD : 100% Polyester enduit Polyuréthane - 300D
- MATELASSAGE: 100% Polyester - 140g/m<sup>2</sup>
- DOUBLURE TAFFETAS: 100% Polyester - 50g/m<sup>2</sup>
- BANDES RÉTRO-RÉFLÉCHISSANTES: Bandes cousues microbilles : 5cm

- OXFORD : 100% Polyester, Polyurethane coated - 300D
- PADDING: 100% Polyester - 140g/m<sup>2</sup>
- TAFFETA LINING: 100% Polyester - 50g/m<sup>2</sup>
- RETRO-REFLECTIVE BANDS: sewn microbead bands : 5cm

## CARACTÉRISTIQUES / FEATURES

- Coutures étanchées
- Capuche fixe intégrée dans le col + Cordon de serrage
- Col montant
- Zip central sous rabat à pressions
- Poignets réglables par scratch
- 2 poches basses sous rabat fermé par scratch
- 1 poche Napoléon sous rabat central
- 1 poche plaquée intérieure fermée par scratch
- Empiècements contrastés: Col + Bas + Poignets
- Bandes cousues : 2 bretelles + 2 ceintures + 2 brassards/manche
- Trappe de marquage
- NB lavages : 20

- Taped seams
- Fixed hood integrated into collar + drawstring
- High collar
- Central zip under snap flap
- Adjustable cuffs by Velcro tab
- 2 lower pockets under flap closed by velcro
- 1 Napoleon pocket under central tab
- 1 inside patch pocket closed by velcro
- Contrasting yokes: Collar + Bottom + Cuffs
- Sewn bands: 2 straps + 2 belts + 2 armbands/sleeve
- Marking access
- NB washes: 20

TAILLES SIZES	S	M	L	XL	2XL
JAUNE HV / MARINE HV YELLOW / NAVY BLUE	7ROAYS	7ROAYM	7ROAYL	7ROAYXL	7ROAYXXL
ORANGE HV / MARINE HV ORANGE / NAVY BLUE	7ROAOS	7ROAOM	7ROAOL	7ROAOXL	7ROAOXXL
CONDITIONNEMENT PACKAGING	Emballage individuel ou par 10 / Individual pack or per 10				



EN 20471

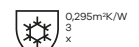

EN 342

# KETA

7KETY / 7KETO / 7KETR



## AVANTAGES / BENEFITS

- PROTECTION: thermique avec l'EN 342 et contre la pluie avec l'EN 343
- FONCTIONNELLE: trappe zippée pour le marquage
- LARGE GRILLE DE TAILLE: XS au 5XL pour le jaune et orange HV
- PROTECTION: thermal with EN 342 and against rain with EN 343
- FUNCTIONAL: zippered flap for marking
- LARGE SIZE GRID: XS to 5XL for yellow and orange HV



7KETO



7KETY



7KETR

## TISSUS / FABRICS

- OXFORD : 100% Polyester enduit Polyuréthane - 300D
- MATELASSAGE: 100% Polyester - 160g/m<sup>2</sup>
- DOUBLURE TAFFETAS: 100% Polyester - 60g/m<sup>2</sup>
- IMPERMÉABILITÉ : 3 000 mm
- BANDES RÉTRO-RÉFLÉCHISSANTES : Bandes cousues microbilles: 5cm

- OXFORD : 100% Polyester, Polyurethane coated - 300D
- PADDING: 100% Polyester - 160g/m<sup>2</sup>
- TAFFETA LINING : 100% Polyester - 60g/m<sup>2</sup>
- WATERPROOFNESS : 3 000 mm
- RETRO-REFLECTIVE BANDS: sewn microbead bands : 5cm

## CARACTÉRISTIQUES / FEATURES

- Coutures étanchées
- Capuche fixe intégrée dans le col + Cordon de serrage
- Col montant
- Zip central à double curseur sous rabat à scratchs
- Manches «Kimonos»
- Poignets coupe-vent en bord-côte
- 2 poches basses sous rabat fermé par scratchs
- 2 poches plaquées intérieures fermées par scratch
- Empiècements contrastés : Épaules + Bas + Poignets
- Œillets d'aération sous les aisselles
- Étiquette d'identification
- Bandes cousues : 2 bretelles + 2 ceintures + 2 brassards/manche
- Trappe de marquage
- NB lavages : 20

- Taped seams
- Fixed hood integrated into collar + drawstring
- High collar
- Central two-way zip under flap with velcro
- «Kimonos» sleeves
- Ribbed windproof cuffs
- 2 lower pockets under flap closed by velcro
- 2 inside patch pockets closed by velcro
- Contrasting yokes: Shoulders + Bottom + Cuffs
- Underarm ventilation eyelets
- Identification label
- Sewn bands: 2 straps + 2 belts + 2 armbands/sleeve
- Marking access
- NB washes: 20

TAILLES SIZES	XS	S	M	L	XL	2XL	3XL	4XL	5XL
ORANGE HV / MARINE HV ORANGE / NAVY BLUE	7KETO XS	7KETO S	7KETO M	7KETO L	7KETO XL	7KETO 2XL	7KETO 3XL	7KETO 4XL	7KETO 5XL
JAUNE HV / MARINE HV YELLOW / NAVY BLUE	7KETY XS	7KETY S	7KETY M	7KETY L	7KETY XL	7KETY XXL	7KETY XXXL	7KETY XXXXL	7KETY XXXXXL
ROUGE HV / MARINE HV RED / NAVY BLUE	-	7KETR S	7KETR M	7KETR L	7KETR XL	7KETR XXL	7KETR XXXL	7KETR XXXXL	7KETR XXXXXL
CONDITIONNEMENT PACKAGING	Emballage individuel ou par 10 / Individual pack or per 10								



EN 20471  
XS



EN 20471  
S+



EN 342



EN 343





# SOKOBIE



Capuche tempête rétractable  
Retractable storm hood

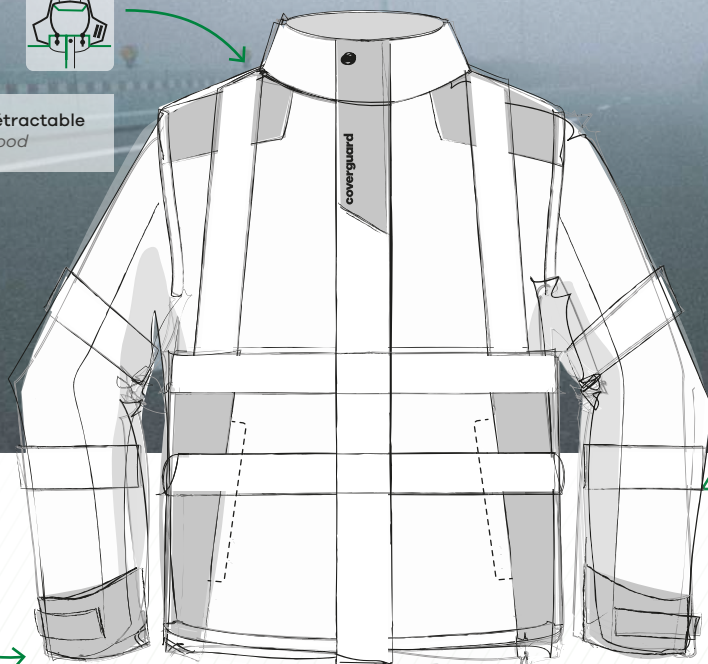

Poignets coupe-vent  
Windproof cuffs



Cordon de serrage  
Drawstring



## FORTE ISOLATION HIGH INSULATION



Pour éviter d'avoir froid, il est important de choisir son vêtement extérieur selon certains critères techniques :

*To avoid being cold, it is important to choose your outer garment according to certain technical criteria:*



Une parka versus un blouson car plus couvrant  
*A parka versus a jacket because it covers more*



Protège du vent/pluie en couvrant la tête et les oreilles efficacement  
*Protects from wind/rain by covering the head and ears effectively*



Étanchéité au froid en bloquant le passage d'air  
*Sealing against cold by blocking the passage of air*



Permet d'ajuster la parka + stocker l'air et le figer afin d'isoler du froid : l'air statique est le meilleur isolant  
*Allows to adjust the parka + store the air and freeze it in order to insulate from the cold: static air is the best insulator*



## FOCUS / FOCUS



REMBOURRAGE SORONA®AURA = FORTE RÉSISTANCE AU FROID

Permet d'isoler sa propre production de chaleur + Haute capacité à transférer l'humidité.

SORONA®AURA PADDING = HIGH COLD RESISTANCE

*Allows to isolate its own heat production + High capacity to transfer humidity.*



OXFORD ENDUIT = DÉPERLANCE & RÉSISTANCE

Structure de tissage solide + traitement de surface permettant à l'eau de ruisseler  
COATED OXFORD = WATER-REPELLENCE & RESISTANCE

*Strong weave structure + surface treatment allowing water to run off*



PARKA / PARKA

# SOKOBIE

5SOK16 / 5SOK17



TEMPS FROID / COLD WEATHER



## AVANTAGES / BENEFITS

- **TECHNIQUE:** rembourrage SORONA® connu pour sa forte préservation de la chaleur + sa légèreté + son origine végétale
- **PROTECTION THERMIQUE:** label de performance d'isolation contre le froid
- **RÉSISTANT ET RESPIRANT:** Oxford enduit PU
- **ANTISALISSURE:** empièchements contrastés dont les entrées de poches
- **TECHNICAL:** SORONA® padding known for its high heat preservation + its lightness + its vegetable origin
- **THERMAL PROTECTION:** performance label for insulation against cold
- **RESISTANT AND BREATHABLE:** PU coated Oxford
- **ANTI FOULING:** contrasting inserts including pocket entries



5SOK17



5SOK16



SOKOBIE FR



SOKOBIE EN



## TISSUS / FABRICS

- **OXFORD:** 100% Polyester enduit Polyuréthane - 300D
- **MATELASSAGE (technologie SORONA®):** 100% Polyester - 140g/m<sup>2</sup>
- **DOUBLURE TAFFETAS:** 100% Polyester - 60g/m<sup>2</sup>
- **IMPERMÉABILITÉ:** 3 000 mm
- **WATERPROOFNESS:** 3 000 mm
- **BANDES RÉTRO-RÉFLÉCHISSANTES:** Bandes cousues microbilles: 5 cm
- **RETRO-REFLECTIVE BANDS:** sewn microbead bands: 5cm

## CARACTÉRISTIQUES / FEATURES

- Coutures étanchées
- Capuche tempête intégrée dans le col + cordon de serrage élastique
- Col montant en polaire
- Zip central à double curseur sous rabat à scratchs
- Protège menton
- Poignets coupe-vent en bord-côte
- Poignets réglables par scratch
- Bas réglables par cordons élastiques
- 2 poches basses zippées sous passepoil
- 1 poche Napoléon
- 2 poches plaquées intérieures fermées par scratch
- Empièchements contrastés: Épaules + Côtés + Poignets
- 1 boucle passe écouteur intérieure
- Bandes cousues: 2 bretelles + 2 ceintures + 2 brassards/manche
- Accès pour marquage
- NB lavages: 25
- Taped seams
- Storm hood integrated into collar + elastic drawcord
- Fleece high collar
- Central two-way zip under flap with velcro
- Chin guard
- Ribbed windproof cuffs
- Adjustable cuffs by velcro
- Adjustable hemline with elastic drawcord
- 2 lower zipped pockets under piping
- 1 Napoleon pocket
- 2 inside patch pockets closed by velcro
- Contrasting yokes: Shoulders + Sides + Cuffs
- 1 earphone loop inside
- Sewn bands: 2 straps + 2 belts + 2 armbands/sleeve
- Branding access
- NB washes: 25



EN 20471



EN 14058



EN 343

TAILLES SIZES	S	M	L	XL	2XL	3XL
<b>JAUNE HV / MARINE</b> HV YELLOW / NAVY BLUE	5SOK16000S	5SOK16000M	5SOK16000L	5SOK1600XL	5SOK1602XL	5SOK1603XL
<b>ORANGE HV / MARINE</b> HV ORANGE / NAVY BLUE	5SOK17000S	5SOK17000M	5SOK17000L	5SOK1700XL	5SOK1702XL	5SOK1703XL
<b>CONDITIONNEMENT</b> PACKAGING	Emballage individuel ou par 5 / Individual pack or per 5					



## LE LABEL DE PERFORMANCE PRODUITS PAR COVERGUARD®

Le label COVERPERF distingue les produits qui par leur développement rigoureux proposent aux utilisateurs, la garantie d'un EPI dont la performance dépasse les prérequis des normes.

Les critères de labellisation conçus par nos équipes techniques internes se veulent exigeants, basés sur l'utilisation et s'appuient sur des tests menés par des laboratoires externes, reconnus et indépendants.

### COVERGUARD® PRODUCTS PERFORMANCES LABEL

*The COVERPERF label distinguishes products which, through their rigorous development, offer users the guarantee of PPE whose performance exceeds the requirements of the standards.*

*The labeling criteria designed by our technical teams are demanding, based on use and supported by tests conducted by external, recognized and independent laboratories.*



#### **Protection thermique** *Thermal protection*

**Vêtement :** 1,85 CLO (sur couche extérieure après lavage) - procure une isolation permettant de travailler à très basses températures (-20°C)

**Clothing:** 1.85 CLO (on outer layer after washing) - provides insulation for insulation to work at very low temperatures (-20°C)



#### **Imperméabilité** *Impermeability*

**Vêtement :** 10 000 Schmerber (10 000 mm sous colonne d'eau ) + le niveau 4/4 du test d'imperméabilité de la norme EN 343

**Clothing:** 10,000 Schmerber (10,000 mm under a water column) + 4/4 level of the impermeability test of standard EN 343



#### **Scannez le QR Code et découvrez COVERPERF**

*Scan the QR Code and find out more on COVERPERF*



PARKA / PARKA

# HORA

5HOR160 / 5HOR170



## AVANTAGES / BENEFITS

- FÉMININE: des découpes pour souligner la silhouette
- GARDE AU CHAUD: Haute isolation thermique avec rembourrage 160g/m<sup>2</sup> + EN 14058
- IMPERMÉABLE: coutures étanchées + Oxford enduit
- ANTISALISSURE: inserts contrastés y compris les entrées de poches
- FEMININE: cut-outs to emphasize the silhouette
- WARMNESS: High thermal insulation with 160g/m<sup>2</sup> padding + EN 14058
- WATERPROOF: taped seams + coated Oxford
- ANTIPOULING: contrasting inserts including pocket entries



5HOR160



5HOR170



## TISSUS / FABRICS

- OXFORD : 100% Polyester enduit Polyuréthane - 300D
- MATELASSAGE: 100% Polyester - 160g/m<sup>2</sup>
- DOUBLURE TAFFETAS: 100% Polyester - 60g/m<sup>2</sup>
- IMPERMÉABILITÉ : 3 000 mm
- BANDES RÉTRO-RÉFLÉCHISSANTES: Bandes cousues microbilles: 5 cm

- OXFORD : 100% Polyester, Polyurethane coated - 300D
- PADDING: 100% Polyester - 160g/m<sup>2</sup>
- TAFFETA LINING: 100% Polyester - 60g/m<sup>2</sup>
- WATERPROOFNESS : 3 000 mm
- RETRO-REFLECTIVE BANDS: sewn microbead bands: 5cm

## CARACTÉRISTIQUES / FEATURES

- Coutures étanchées
- Capuche tempête intégrée dans le col + cordon de serrage élastique
- Col montant en polaire
- Zip central à double curseur sous rabat à scratchs
- Protège menton
- Poignets coupe-vent en bord-côte
- Poignets réglables par scratch
- Bas réglables par cordons élastiques
- 2 poches basses zippées sous passepoil
- 1 poche Napoléon
- 2 poches plaquées intérieures fermées par scratch
- Empièchements contrastés: Épaules + Côtés + Poignets
- Découpes princesses
- 1 boucle passe écouteur intérieure
- Étiquette d'identification
- Bandes cousues : 2 bretelles + 2 ceintures + 2 brassards/manche
- Accès pour marquage
- NB lavages : 25

- Taped seams
- Storm hood integrated into collar + elastic drawcord
- Fleece high collar
- Central two-way zip under flap with velcro
- Chin guard
- Ribbed windproof cuffs
- Adjustable cuffs by velcro
- Adjustable hemline with elastic drawcord
- 2 lower zipped pockets under piping
- 1 Napoleon pocket
- 2 inside patch pockets closed by velcro
- Contrasting yokes: Shoulders + Sides + Cuffs
- Princess cut
- 1 earphone loop inside
- Identification label
- Sewn bands: 2 straps + 2 belts + 2 armbands/sleeve
- Branding access
- NB washes: 25



EN 20471



EN 14058



EN 343

TAILLES SIZES	XS	S	M	L	XL	2XL
ORANGE HV / MARINE HV ORANGE / NAVY BLUE	5HOR1700XS	5HOR17000S	5HOR17000M	5HOR17000L	5HOR1700XL	5HOR1702XL
JAUNE HV / MARINE HV YELLOW / NAVY BLUE	5HOR1600XS	5HOR16000S	5HOR16000M	5HOR16000L	5HOR1600XL	5HOR1602XL
CONDITIONNEMENT PACKAGING	Emballage individuel ou par 5 / Individual pack or per 5					







# KANPA

Softshell 3 couches  
3 layers softshell

Bandes réfléchissantes  
Reflective bands



Poignets élastiqués  
Elasticated cuff



Cordon de serrage  
Drawstring



## ISOLATION THERMIQUE THERMAL INSULATION

Son complexe 3 couches permet une protection contre le froid grâce à son action coupe-vent et son apport de chaleur (intérieur polaire)

*Its 3-layer complex provides protection against the cold thanks to its windproof action and its warmth (fleece inside)*

Tissu extérieur  
Outer fabric

Membrane  
Membrane

Doublure  
Lining

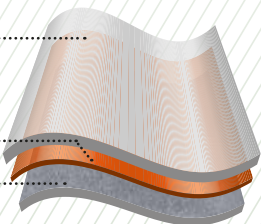

## FOCUS / FOCUS

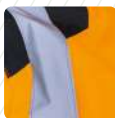

VISIBILITÉ / VISIBILITY

Des bandes microbilles situées sur toutes les zones dont les bretelles afin d'être vu sous toutes les postures et dans toutes les situations

*Microbead bands on all areas including the shoulder straps to be seen in all postures and situations*



## IMPERMÉABILITÉ WATERPROOFNESS

La membrane permet à l'eau de ne pas traverser l'ensemble des couches  
*The membrane ensures that water does not pass through all the layers*



# KANPA

5KPA16 / 5KPA17



## AVANTAGES / BENEFITS

- **PERFORMANT:** forte imper-respirabilité de la membrane: 8 000mm - 3 000g/m<sup>2</sup>/24h
- **ANTISALISSURE:** empiecements contrastés dont sur les entrées de poches
- **VISIBLE:** bandes bretelles pour être perçu penché ou avec une vue de dessus
- **PERFORMING:** high waterproof-breathability of the membrane: 8 000mm - 3 000g/m<sup>2</sup>/24h
- **ANTI FOULING:** contrasting inserts on pocket entries
- **VISIBLE:** straps to be perceived leaning or with a top view



5KPA16



5KPA17

## TISSUS / FABRICS

- **SOFTSHELL 3 COUCHES :** 100% Polyester stretch mécanique + Membrane TPU + Micro-polaire - 295g/m<sup>2</sup>
- **IMPERMÉABILITÉ :** 8 000 mm
- **RESPIRABILITÉ :** 3 000 g/m<sup>2</sup>/24h
- **3-LAYER SOFTSHELL :** 100% Polyester mechanical stretch + TPU membrane + Micro-fleece - 295g/m<sup>2</sup>
- **WATERPROOFNESS :** 8 000 mm
- **BREATHABILITY :** 3 000 g/m<sup>2</sup>/24h
- **BANDES RÉTRO-RÉFLÉCHISSANTES :** Bandes cousues microbilles: 5 cm
- **RETRO-REFLECTIVE BANDS:** sewn microbead bands : 5cm

## CARACTÉRISTIQUES / FEATURES

- Col montant
- Protège menton
- Zip central
- Poignets élastiqués
- 2 poches basses zippées sous passepoil
- Empiecements contrastés : Épaules + Côtés + Poignets
- Bandes cousues: 2 bretelles + 2 ceintures + 2 brassards/manche
- High collar
- Chin protection
- Central zipper
- Elasticated cuffs
- 2 lower zipped pockets under piping
- Contrasting yokes: Shoulders + Sides + Cuffs
- Sewn bands: 2 straps + 2 belts + 2 armbands/sleeve

TAILLES SIZES	S	M	L	XL	2XL	3XL	4XL
<b>JAUNE HV / MARINE</b> HV YELLOW / NAVY BLUE	5KPA16000S	5KPA16000M	5KPA16000L	5KPA1600XL	5KPA1602XL	5KPA1603XL	5KPA1604XL
<b>ORANGE HV / MARINE</b> HV ORANGE / NAVY BLUE	5KPA17000S	5KPA17000M	5KPA17000L	5KPA1700XL	5KPA1702XL	5KPA1703XL	5KPA1704XL
<b>CONDITIONNEMENT</b> PACKAGING	Emballage individuel ou par 10 / Individual pack or per 10						



EN 20471  
S + M



EN 20471  
L+



## VESTE SOFTSHELL / SOFTSHELL JACKET

# STATION

MO70630 / MO70640 / MO70680



### AVANTAGES / BENEFITS

- PROTECTION: contre les faibles intempéries
- PRATIQUE: capuche cachée + manches amovibles
- PERFORMANTE: membrane hautement imperméable (8 000mm) et respirante
- PROTECTION: against light weather
- PRACTICAL: hidden hood + removable sleeves
- PERFORMANT: highly waterproof (8 000mm) and breathable membrane



MO70640



MO70630



MO70680

### TISSUS / FABRICS

- SOFTSHELL 3 COUCHES : 100% Polyester stretch mécanique + Membrane TPU + Micro-polaire - 300g/m<sup>2</sup>
- IMPERMÉABILITÉ : 8 000 mm
- RESPIRABILITÉ : 3 000 g/m<sup>2</sup>/24h
- BANDES RÉTRO-RÉFLÉCHISSANTES 3M® : Bandes cousues microbilles: 5cm
- 3-LAYER SOFTSHELL : 100% Polyester mechanical stretch + TPU membrane + Micro-fleece - 300g/m<sup>2</sup>
- WATERPROOFNESS : 8 000 mm
- BREATHABILITY : 3 000 g/m<sup>2</sup>/24h
- RETRO-REFLECTIVE BANDS 3M®: sewn microbead bands : 5cm

### CARACTÉRISTIQUES / FEATURES

- Capuche fixe intégrée dans le col + cordon de serrage élastiqué & bloqueurs
- Col montant
- Zip central
- Manches amovibles
- Poignets semi-élastiqués + Patte de serrage à scratch
- Bas réglable par cordon élastique & bloqueurs
- 2 poches basses zippées sous passepoil
- 1 poche poitrine zippée sous passepoil
- 2 poches basses intérieures
- Empiècements contrastés: Bas + Poignets
- Protège reins
- Bandes cousues: 2 bretelles + 2 ceintures + 2 brassards/manche
- NB lavages : 25
- Fixed hood integrated into collar + elastic drawstring & blockers
- High collar
- Central zipper
- Removable sleeves
- Semi-elasticated cuffs + Velcro tab
- Adjustable hemline with elastic drawstring & blockers
- 2 lower zipped pockets under piping
- 1 zipped chest pocket under piping
- 2 lower inside pockets
- Contrasting yokes: Bottom + Cuffs
- Kidney protection
- Sewn bands: 2 straps + 2 belts + 2 armbands/sleeve
- NB washes: 25



EN 20471  
Gilet /  
Bodywarmer



EN 20471  
Veste / Jacket  
(S)



EN 20471  
Veste / Jacket  
(M+)

TAILLES SIZES	S	M	L	XL	2XL	3XL
ORANGE HV / MARINE HV ORANGE / NAVY BLUE	70639	70640	70641	70642	70643	70644
JAUNE HV / MARINE HV YELLOW / NAVY BLUE	70629	70630	70631	70632	70633	70634
ROUGE HV / MARINE HV RED / NAVY BLUE	70679	70680	70681	70682	70683	70684
CONDITIONNEMENT PACKAGING	Emballage individuel ou par 10 / Individual pack or per 10					

# KAZAN

5KAS160 / 5KAS170



## AVANTAGES / BENEFITS

- PROTECTION: contre les faibles intempéries
- CONFORT: bandes segmentées + matière souple
- COMBINABLE: avec les parkas KAZAN + SANGAKU
- LARGE GRILLE DE TAILLE: S au 4XL
- PROTECTION: against light weather
- COMFORT: segmented bands + soft material
- COMBINABLE: with KAZAN + SANGAKU parkas
- LARGE SIZE GRID: S to 4XL



5KAS160



5KAS170



KAZAN



SANGAKU

## TISSUS / FABRICS

- SOFTSHELL 3 COUCHES : 100% Polyester + Membrane TPU + Micro-polaire - 300g/m<sup>2</sup>
- IMPERMÉABILITÉ : 3 000 mm
- BANDES RÉTRO-RÉFLÉCHISSANTES : Bandes segmentées microbilles: 5cm

- 3-LAYER SOFTSHELL : 100% Polyester + TPU membrane + Micro-fleece - 300g/m<sup>2</sup>
- WATERPROOFNESS : 3 000 mm
- RETRO-REFLECTIVE BANDS: Segmented microbead bands : 5cm

## CARACTÉRISTIQUES / FEATURES

- Col montant
- Zip central
- Poignets avec biais élastiqués
- 2 poches basses zippées
- 1 poche poitrine zippée
- 2 grandes poches basses intérieures
- Empiècements contrastés: Épaules + Bas + Poignets
- Attaches pour fixation à la parka
- Protège reins
- Bandes segmentées: 2 bretelles + 2 ceintures + 2 brassards/manche
- NB lavages : 20

- High collar
- Central zipper
- Cuffs with elasticated bias
- 2 lower zipped pockets
- 1 zipped chest pocket
- 2 large lower inside pockets
- Contrasting yokes: Shoulders + Bottom + Cuffs
- Loops to combine with the parka
- Kidney protection
- Segmented bands: 2 straps + 2 belts + 2 armbands/sleeve
- NB washes: 20

TAILLES SIZES	S	M	L	XL	2XL	3XL
JAUNE HV / MARINE HV YELLOW / NAVY BLUE	5KAS16000S	5KAS16000M	5KAS16000L	5KAS1600XL	5KAS1602XL	5KAS1603XL
ORANGE HV / MARINE HV ORANGE / NAVY BLUE	-	5KAS17000M	5KAS17000L	5KAS1700XL	5KAS1702XL	-
CONDITIONNEMENT PACKAGING	Emballage individuel ou par 10 / Individual pack or per 10					



EN 20471



## VESTE 2/1 / 2/1 JACKET

# KAZAN

5KAJ170 / 5KAJ160



### AVANTAGES / BENEFITS

- IMPERMÉABILITÉ: Oxford enduit + coutures étanchées
- CONFORT: doublure chaude en polaire + poignets bord-côtes
- FONCTIONNELLE: convertible en gilet + trappe de marquage
- COMBINABLE: avec les parkas KAZAN + SANGAKU
- WATERPROOF: coated Oxford + taped seams
- COMFORT: warm, fleece lining + ribbed cuffs
- FUNCTIONAL: convertible into a vest + marking flap
- COMBINABLE: with KAZAN + SANGAKU parkas



5KAJ160



5KAJ170



KAZAN



SANGAKU



### TISSUS / FABRICS

- OXFORD : 100% Polyester enduit Polyuréthane - 300D
- DOUBLURE POLAIRE : 100% Polyester - 280g/m<sup>2</sup> (Corps)
- MATELASSAGE : 100% Polyester - 120g/m<sup>2</sup> (Manches)
- DOUBLURE TAFFETAS : 100% Polyester - 60g/m<sup>2</sup> (Manches)
- IMPERMÉABILITÉ : 3 000 mm
- BANDES RÉTRO-RÉFLÉCHISSANTES : Bandes cousues microbilles: 5cm
- OXFORD : 100% Polyester, Polyurethane coated - 300D
- FLEECE LINING: 100% Polyester. 280g/m<sup>2</sup> (Body)
- PADDING: 100% Polyester - 120g/m<sup>2</sup> (Sleeves).
- TAFFETA LINING: 100% Polyester - 60g/m<sup>2</sup> (Sleeves)
- WATERPROOFNESS : 3 000 mm
- RETRO-REFLECTIVE BANDS: sewn microbead bands : 5cm

### CARACTÉRISTIQUES / FEATURES

- Coutures étanchées
- Col montant doublé en polaire
- Zip central
- Manches amovibles
- Poignets coupe-vent en bord-côte
- 2 poches basses zippées sous passepoil
- 1 poche poitrine zippée sous passepoil
- 1 poche plaquée intérieure fermée par scratch
- Attaches pour fixation à la parka
- Étiquette d'identification
- Protège reins
- Bandes cousues : 2 bretelles + 2 ceintures + 2 brassards/manche
- Trappe de marquage
- Taped seams
- Fleece lined stand-up collar
- Central zipper
- Removable sleeves
- Ribbed wind cuffs
- 2 lower zipped pockets under piping
- 1 chest pocket with zip under piping
- 1 inside patch pocket closed by velcro
- Loops to combine with the parka
- Identification label
- Kidney protection
- Sewn bands: 2 straps + 2 belts + 2 armbands/sleeve
- Marking access



EN 20471  
Gilet froid /  
Bodywarmer



EN 20471  
Veste / Jacket



EN 14058

TAILLES SIZES	S	M	L	XL	2XL	3XL	4XL
ORANGE HV / MARINE HV ORANGE / NAVY BLUE	5KAJ17000S	5KAJ17000M	5KAJ17000L	5KAJ1700XL	5KAJ1702XL	5KAJ1703XL	5KAJ1704XL
JAUNE HV / MARINE HV YELLOW / NAVY BLUE	5KAJ16000S	5KAJ16000M	5KAJ16000L	5KAJ1600XL	5KAJ1602XL	5KAJ1603XL	5KAJ1604XL
CONDITIONNEMENT PACKAGING	Emballage individuel ou par 10 / Individual pack or per 10						

# HI-WAY

MO70530\*



## AVANTAGES / BENEFITS

- PRATIQUE : manches amovibles
- CONFORT : polaire sur les manches et à l'intérieur + dos ultra rallongé
- PRACTICAL : removable sleeves
- COMFORT : fleece on the sleeves and inside + ultra long back



MO70530



## TISSUS / FABRICS

- OXFORD : 100% Polyester enduit Polyuréthane - 300D
- POLAIRE: 100% Polyester - 280g/m<sup>2</sup> (manches + col)
- DOUBLURE POLAIRE: 100% Polyester - 280g/m<sup>2</sup>
- BANDES RÉTRO-RÉFLÉCHISSANTES 3M®: Bandes cousues microbilles: 5cm

- OXFORD: 100% Polyester, Polyurethane coated - 300D
- FLEECE: 100% Polyester - 280g/m<sup>2</sup> (sleeves + collar)
- FLEECE LINING: 100% Polyester - 280g/m<sup>2</sup>
- RETRO-REFLECTIVE BANDS 3M®: sewn microbead bands : 5cm

## CARACTÉRISTIQUES / FEATURES

- Coutures étanches
- Col montant contrasté
- Zip central
- Manches amovibles
- Poignets élastiques
- Ceinture élastiquée
- 2 poches basses sous passepoil
- 1 poche poitrine zippée sous passepoil
- Protège reins
- Bandes cousues: 2 bretelles + 2 ceintures + 2 brassards/manche
- Trappe de marquage côté
- NB lavages : 25

- Taped seams
- Contrasted high collar
- Central zipper
- Removable sleeves
- Elasticated cuff
- Elasticated waistband on sides
- 2 lower pockets under piping
- 1 chest pocket with zip under piping
- Kidney protection
- Sewn bands: 2 straps + 2 belts + 2 armbands/sleeve
- Marking access on side
- NB washes: 25



EN 20471  
Gilet froid /  
Bodywarmer



EN 20471  
Veste / Jacket



EN 14058  
Veste / Jacket



EN 343  
Veste / Jacket

TAILLES SIZES	M	L	XL	2XL
ORANGE HV* HV ORANGE*	70530	-	70532	70533
CONDITIONNEMENT PACKAGING	Emballage individuel ou par 10 / Individual pack or per 10			

\* Dans la limite des stocks disponibles / Within the limit of the available stock



## VESTE 2/1 / 2/1 JACKET

# HI-WAY

7HWXY / 7HWXO



### AVANTAGES / BENEFITS

- CONFORT: dos rallongé + zones en polaire
- PRATIQUE: manches amovibles + trappe de marquage
- VISIBLE: bandes bretelles pour être perçu penché ou avec une vue de dessus
- COMFORT: extended back + fleece areas
- PRACTICAL: removable sleeves + branding access
- VISIBLE: straps to be seen leaning or with a top view

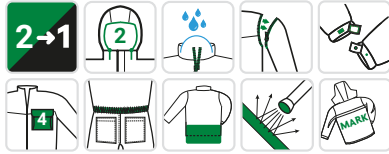

7HWXY



7HWXO

### TISSUS / FABRICS

- OXFORD: 100% Polyester enduit Polyuréthane - 300D
- MATELASSAGE: 100% Polyester - 120g/m<sup>2</sup> (manches + corps)
- DOUBLURE TAFFETAS: 100% Polyester - 60g/m<sup>2</sup> (manches + corps)
- DOUBLURE POLAIRE: 100% Polyester - 280g/m<sup>2</sup> (col + haut du dos)
- OXFORD: 100% Polyester, Polyurethane coated - 300D
- PADDING: 100% Polyester - 120g/m<sup>2</sup> (body + sleeves)
- TAFFETA LINING: 100% Polyester - 60g/m<sup>2</sup> (body + sleeves)
- FLEECE LINING: 100% Polyester. 280g/m<sup>2</sup> (collar + upper back)
- BANDES RÉTRO-RÉFLÉCHISSANTES: Bandes cousues microbilles: 5cm
- RETRO-REFLECTIVE BANDS: sewn microbead bands: 5cm

### CARACTÉRISTIQUES / FEATURES

- Coutures étanchées
- Capuche fixe intégrée dans le col + Cordon de serrage
- Col montant
- Zip central + sous-patte
- Manches amovibles
- Poignets réglables par scratch
- Ceinture élastiquée
- 2 poches basses fermées par scratch
- 1 poche poitrine fermée par zip étanche
- 1 poche plaquée intérieure
- 1 passant poitrine
- Empiècement contrasté: Bas de la veste
- Protège reins
- Bandes cousues: 2 épaules + 2 ceintures + 2 brassards/manche
- Trappe de marquage
- NB lavages: 20
- Taped seams
- Fixed hood integrated into collar + drawstring & blockers
- High collar
- Central zipper + under flap
- Removable sleeves
- Adjustable cuffs by velcro
- Elasticated waistband on sides
- 2 lower pockets closed by velcro
- 1 waterproof zipped chest pocket
- 1 inside patch pocket
- 1 chest loop
- Contrasting yoke: bottom of jacket
- Kidney protection
- Sewn bands: 2 shoulders + 2 belts + 2 armbands/sleeve
- Marking access
- NB washes: 20



EN 20471  
Veste / Jacket



EN 14058  
Veste / Jacket



EN 343

TAILLES SIZES	S	M	L	XL	2XL	3XL
JAUNE HV / NOIR HV YELLOW / BLACK	7HWXYS	7HWXYM	7HWXYL	7HWXYXL	7HWXYXXL	7HWXYXXXL
ORANGE HV / NOIR HV ORANGE / BLACK	7HWXOS	7HWXOM	7HWXOL	7HWXOXL	7HWXOXXL	7HWXOXXXL
CONDITIONNEMENT PACKAGING	Emballage individuel ou par 10 / Individual pack or per 10					



# FLAKE

5FLA160 / 5FLA170



## AVANTAGES / BENEFITS

- **TECHNIQUE:** technologie SORONA® qui apporte chaleur et légèreté
- **PERFORMANTE:** déperlant avec la membrane TPU + résistance à la déchirure
- **CONFORT:** bandes segmentées
- **ECO-RESPONSABLE:** le rembourrage SORONA® est en partie biosourcé
- **TECHNICAL:** SORONA® technology that brings warmth and lightness
- **PERFORMING:** water repellent with TPU membrane + tear resistance
- **COMFORT:** segmented bands
- **ECO-RESPONSIBLE:** the SORONA® padding is partly biosourced

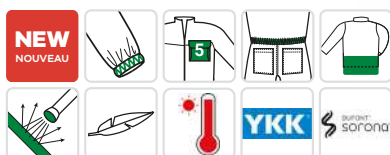

5FLA160



5FLA170

## TISSUS / FABRICS

- **EXTÉRIEUR:** 100% Polyester stretch mécanique 150D + membrane TPU - 130g/m<sup>2</sup>
- **MATELASSAGE (technologie SORONA®):** 100% Polyester - 100g/m<sup>2</sup> (corps) + 80g/m<sup>2</sup> (manches)
- **DOUBLURE TAFFETAS:** 100% Polyester - 65g/m<sup>2</sup>
- **DOUBLURE POLAIRE:** 100% Polyester - 140g/m<sup>2</sup> (col)
- **BANDES RÉTRO-RÉFLÉCHISSANTES:** Bandes segmentées microbilles: 5cm
- **OUTER:** 100% Polyester mechanical stretch 150D + TPU membrane - 130g/m<sup>2</sup>
- **PADDING (SORONA® technology):** 100% Polyester - 100g/m<sup>2</sup> (body) + 80g/m<sup>2</sup> (sleeves)
- **TAFFETA LINING:** 100% Polyester - 65g/m<sup>2</sup>
- **FLEECE LINING:** 100% Polyester - 140g/m<sup>2</sup> (collar)
- **RETRO-REFLECTIVE BANDS:** segmented microbead bands: 5cm

## CARACTÉRISTIQUES / FEATURES

- Col montant
- Zip central YKK + Protège menton
- Ceinture en biais élastiqué
- Poignets avec biais élastiques
- 1 poche poitrine sous passepoil
- 2 poches basses sous passepoils
- 2 poches plaquées intérieures fermées par scratch
- Empiècements contrastés : Col + Épaules + Côtés
- Dos rallongé
- Bandes segmentées: 2 épaules + 2 ceintures + 2 brassards/manche
- NB lavages : 20
- High collar
- YKK central zip + Chin guard
- Elasticated bias belt
- Cuffs with elasticated bias
- 1 zipped chest pocket under piping
- 2 lower pockets under piping
- 2 inside patch pockets closed by velcro
- Contrasting yokes: Collar + Shoulders + Sides
- Extended back
- Segmented bands: 2 shoulders + 2 belts + 2 armbands/sleeve
- NB washes: 20

TAILLES SIZES	S	M	L	XL	2XL	3XL
JAUNE HV / MARINE HV YELLOW / NAVY BLUE	5FLA16000S	5FLA16000M	5FLA16000L	5FLA1600XL	5FLA1602XL	5FLA1603XL
ORANGE HV / MARINE HV ORANGE / NAVY BLUE	5FLA17000S	5FLA17000M	5FLA17000L	5FLA1700XL	5FLA1702XL	5FLA1703XL
CONDITIONNEMENT PACKAGING	Emballage individuel ou par 10 / Individual pack or per 10					





# RITTO

5RIT170 / 5RIT160



## AVANTAGES / BENEFITS

- UN BASIQUE: simple tout en étant protectrice
- CONFORT ET CHALEUR: la polaire est une deuxième couche douce et isolante
- A BASIC: simple yet protective
- COMFORT AND WARMNESS: the fleece is a soft and insulating second layer



5RIT170



5RIT160

## TISSUS / FABRICS

- POLAIRE: 100% Polyester - 280g/m<sup>2</sup>
- BANDES RÉTRO-RÉFLÉCHISSANTES: Bandes cousues microbilles: 5cm
- FLEECE: 100% Polyester - 280g/m<sup>2</sup>
- RETRO-REFLECTIVE BANDS: sewn microbead bands: 5cm

## CARACTÉRISTIQUES / FEATURES

- Col montant
- Zip central
- Protège menton
- Poignets élastiqués
- Bas réglable par cordon élastique
- 2 poches basses zippées
- 1 poche poitrine zippée
- 2 poches basses intérieures
- Bandes cousues: 2 ceintures + 2 brassards/manche
- NB lavages : 25
- High collar
- Central zipper
- Chin guard
- Elasticated cuff
- Adjustable hemline with elastic drawcord
- 2 zipped lower pockets
- 1 zipped chest pocket
- 2 inside lower pockets
- Sewn bands: 2 belts + 2 armbands/sleeve
- NB washes: 25

TAILLES SIZES	S	M	L	XL	2XL	3XL	4XL
ORANGE HV HV ORANGE	5RIT17000S	5RIT17000M	5RIT17000L	5RIT17000XL	5RIT1702XL	5RIT1703XL	5RIT1704XL
JAUNE HV HV YELLOW	5RIT16000S	5RIT16000M	5RIT16000L	5RIT16000XL	5RIT1602XL	5RIT1603XL	5RIT1604XL
CONDITIONNEMENT PACKAGING	Emballage individuel ou par 10 / Individual pack or per 10						



EN 20471  
S-L



EN 20471  
XL+



# STATION

7PSTY / 7PSTO



## AVANTAGES / BENEFITS

- ISOLATION: polaire épaisse
- FONCTIONNELLE: manches amovibles
- ANTISALISSURE: empiècements contrastés
- INSULATION: thick fleece
- FUNCTIONAL: removable sleeves
- ANTIFOULING: contrasting inserts



7PSTO

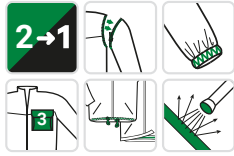

7PSTY



## TISSUS / FABRICS

- POLAIRE : 100% Polyester - 330g/m<sup>2</sup>
- BANDES RÉTRO-RÉFLÉCHISSANTES: Bandes cousues microbilles: 5cm
- FLEECE : 100% Polyester - 330g/m<sup>2</sup>
- RETRO-REFLECTIVE BANDS: sewn microbead bands: 5cm

## CARACTÉRISTIQUES / FEATURES

- Col montant
- Zip central
- Manches amovibles
- Poignets élastiqués
- Bas réglable par cordon élastiqué & bloqueurs
- 2 poches basses zippées
- 1 poche poitrine zippée
- Empiècements contrastés : Col + Bas + Poignets
- Bandes cousues: 2 bretelles + 2 ceintures + 2 brassards/manche
- High collar
- Central zipper
- Removable sleeves
- Elasticated cuff
- Adjustable hemline with elastic drawstring & blockers
- 2 zipped lower pockets
- 1 zipped chest pocket
- Contrasting yokes: Collar + Bottom + Cuffs
- Sewn bands: 2 straps + 2 belts + 2 armbands/sleeve



**EN 20471**  
Gilet /  
Bodywarmer (S)



**EN 20471**  
Gilet /  
Bodywarmer (M+)



**EN 20471**  
Veste / Jacket  
(S)



**EN 20471**  
Veste / Jacket  
(M+)

TAILLES SIZES	S	M	L	XL	2XL	3XL
<b>JAUNE HV / MARINE</b> HV YELLOW / NAVY BLUE	7PSTYS	7PSTYM	7PSTYL	7PSTYXL	7PSTYXXL	7PSTYXXXL
<b>ORANGE HV / MARINE</b> HV ORANGE / NAVY BLUE	7PSTOS	7PSTOM	7PSTOL	7PSTO0XL	7PSTOXXL	7PSTOXXXL
<b>CONDITIONNEMENT</b> PACKAGING	Emballage individuel ou par 10 // Individual pack or per 10					



# GOKKAN

5GOK17 / 5GOK16 / 5GOK130



## AVANTAGES / BENEFITS

- CONFORT: maille grattée envers
- ANTISALISSURE: inserts contrastés y compris les entrées de poches
- PLURI-SAISONNALITÉ: peut se porter toute l'année
- FONCTIONNELLE: zip central pour facilité l'enfilage
- COMFORT: back-scratch knit
- ANTIFOULING: contrasting inserts including pocket entries
- MULTI-SEASONAL: can be worn all year round
- FUNCTIONAL: central zip for easy donning



5GOK17



5GOK16



5GOK130

TEMPS FROID / COLD WEATHER

## TISSUS / FABRICS

- MOLLETON: 75% Polyester / 25% Coton - 300g/m<sup>2</sup>
- BORD-CÔTE: 100% Polyester
- BANDES RÉTRO-RÉFLÉCHISSANTES: Bandes cousues microbilles: 5cm
- FLEECE: 75% Polyester / 25% Cotton - 300g/m<sup>2</sup>
- RIB: 100% Polyester
- RETRO-REFLECTIVE BANDS: sewn microbead bands: 5cm

## CARACTÉRISTIQUES / FEATURES

- Col montant
- Zip central
- Poignets bord-côtes
- Ceinture en bord-côte
- 2 poches basses sous passepoil
- 2 poches basses intérieures
- Empiècements contrastés: Col + Épaules + Côtés + Poignets
- Bandes cousues: 2 épaules + 2 ceintures + 2 brassards/manche
- NB lavages: 25
- High collar
- Central zipper
- Elasticated rib cuff
- Elasticated ribbed waistband
- 2 lower pockets under piping
- 2 inside lower pockets
- Contrasting yokes: Collar + Shoulders + Sides + Cuffs
- Sewn bands: 2 shoulders + 2 belts + 2 armbands/sleeve
- NB washes: 25

TAILLES SIZES	S	M	L	XL	2XL	3XL
ORANGE HV / MARINE HV ORANGE / NAVY BLUE	5GOK1700S	5GOK1700M	5GOK1700L	5GOK170XL	5GOK172XL	5GOK173XL
JAUNE HV / MARINE HV YELLOW / NAVY BLUE	5GOK1600S	5GOK1600M	5GOK1600L	5GOK160XL	5GOK162XL	5GOK163XL
ROUGE HV / MARINE HV RED / NAVY BLUE	5GOK1300S	5GOK1300M	5GOK1300L	5GOK1300XL	5GOK1302XL	5GOK1303XL
CONDITIONNEMENT PACKAGING	Emballage individuel ou par 10 / Individual pack or per 10					



EN 20471



# SOUKOU

5SOU160 / 5SOU170



## AVANTAGES / BENEFITS

- **BASIQUE:** une couleur + 8 bandes
- **CONFORT:** manches «Kimono» pour une liberté de mouvement
- **PRATIQUE:** porte badge + capuche repliable
- **BASIC:** one color + 8 stripes
- **COMFORT:** «Kimono» sleeves for freedom of movement
- **PRACTICAL:** badge holder + foldable hood

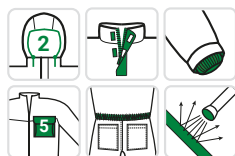

5SOU160



5SOU170

## TISSUS / FABRICS

- **OXFORD:** 100% Polyester enduit Polyuréthane - 300D
- **MATELASSAGE:** 100% Polyester - 160g/m<sup>2</sup> (corps) + 140g/m<sup>2</sup> (manches)
- **DOUBLURE TAFFETAS:** 100% Polyester - 50g/m<sup>2</sup>
- **IMPERMÉABILITÉ :** 3 000 mm
- **BANDES RÉTRO-RÉFLÉCHISSANTES:** Bandes cousues microbilles : 5cm de large
- **OXFORD:** 100% Polyester, PU coated - 300D
- **PADDING:** 100% Polyester - 160g/m<sup>2</sup> (body) + 140g/m<sup>2</sup> (sleeves)
- **TAFFETA LINING:** 100% Polyester - 50g/m<sup>2</sup>
- **WATERPROOFNESS :** 3 000 mm
- **RETRO-REFLECTIVE BANDS:** sewn microbead bands: 5cm

## CARACTÉRISTIQUES / FEATURES

- Coutures étanchées
- Capuche fixe intégrée dans le col + Cordon de serrage élastiqué & bloqueurs
- Col montant
- Zip central double curseur sous rabat à scratch
- Ceinture élastiquée
- Manches effet Kimono
- Poignets coupe vent en bord-côte
- 1 poche poitrine plaquée avec rabat fermé par scratch + Porte badge plastique
- 2 poches basses verticales sous rabat
- 1 poche Napoléon
- 1 poche plaquée intérieure fermée par scratch
- Bandes cousues : 2 bretelles + 2 ceintures + 2 brassards/manche
- Taped seams
- Fixed hood concealed in the collar + Elasticated drawstring & blockers
- High collar
- Central zip under flap with velcro
- Elasticated belt
- Kimono effect sleeves
- Ribbed windproof cuffs
- 1 patch chest pocket with flap closed by velcro + Plastic badge holder
- 2 vertical lower pockets under flap
- 1 Napoleon pocket
- 1 inside patch pocket closed by velcro
- Sewn bands: 2 straps + 2 belts + 2 armbands/sleeve



EN 20471



EN 14058



EN 343

TAILLES SIZES	S	M	L	XL	2XL	3XL	4XL
<b>JAUNE HV</b> HV YELLOW	5SOU16000S	5SOU16000M	5SOU16000L	5SOU1600XL	5SOU1602XL	5SOU1603XL	5SOU1604XL
<b>ORANGE HV</b> HV ORANGE	5SOU17000S	5SOU17000M	5SOU17000L	5SOU1700XL	5SOU1702XL	5SOU1703XL	5SOU1704XL
<b>CONDITIONNEMENT</b> PACKAGING	Emballage individuel ou par 10 / Individual pack or per 10						

# AIRPORT

7AIBO / 7AIBY



## AVANTAGES / BENEFITS

- PROTECTION: normé EN 342 + EN 343
- ANTIFOUILLAGE: empiècements contrastés sur le haut et sur le bas
- CONFORT: intérieur du col en polaire
- PROTECTION: EN 342 + EN 343 standard
- ANTIFOUILLAGE: contrasted inserts on top and bottom
- COMFORT: inside of the collar in fleece



7AIBO



7AIBY

## TISSUS / FABRICS

- OXFORD (fluo) : 100% Polyester enduit Polyuréthane - 300D
- OXFORD (marine): 100% Polyamide - 210D
- MATELASSAGE: 100% Polyester - 160g/m<sup>2</sup>
- DOUBLURE TAFFETAS: 100% Polyester - 60g/m<sup>2</sup>
- DOUBLURE POLAIRE: 100% Polyester (col)
- OXFORD (fluo): 100% Polyester, Polyurethane coated - 300D
- OXFORD (navy): 100% Polyamide - 210D
- PADDING: 100% Polyester - 160g/m<sup>2</sup>
- TAFFETA LINING: 100% Polyester - 60g/m<sup>2</sup>
- FLEECE LINING: 100% Polyester (collar)
- BANDES RÉTRO-RÉFLÉCHISSANTES 3M®: Bandes cousues microbilles: 5cm
- RETRO-REFLECTIVE BANDS 3M®: sewn microbead bands : 5cm

## CARACTÉRISTIQUES / FEATURES

- Coutures étanchées
- Capuche fixe intégrée dans le col + Cordon de serrage
- Col montant
- Zip central à double curseur sous rabat à scratchs + 2 pressions
- Manches Kimono
- Poignets semi-élastiqués + Patte de serrage à scratch
- Ceinture élastiquée
- 2 poches basses sous passepoil
- 1 poche poitrine zippée sous passepoil
- 1 poche plaquée intérieure fermée par scratch
- Empiècements contrastés : Haut + Bas + Poignets
- Bandes cousues: 2 bretelles + 2 ceintures + 2 brassards/manche
- Passepoil rétro-réfléchissant
- Trappe de marquage
- NB lavages : 20
- Taped seams
- Fixed hood integrated into collar + drawstring & blockers
- High collar
- Central zipper with double slider under velcro flap + 2 snaps
- Kimono sleeves
- Semi-elasticated cuffs + Velcro tab
- Elasticated waistband
- 2 lower pockets under piping
- 1 chest pocket with zip under piping
- 1 inside patch pocket closed by velcro
- Contrasting yokes: Top + Bottom + Cuffs
- Sewn bands: 2 straps + 2 belts + 2 armbands/sleeve
- Retro-reflective piping
- Marking access
- NB washes: 20



EN 20471



EN 342



EN 343

TAILLES SIZES	S	M	L	XL	2XL	3XL
ORANGE HV / MARINE HV ORANGE / NAVY BLUE	-	7AIBOM	7AIBOL	7AIBOXL	7AIBOXXL	-
JAUNE HV / MARINE HV YELLOW / NAVY BLUE	7AIBYS	7AIBYM	7AIBYL	7AIBYXL	7AIBYXXL	7AIBYXXXL
CONDITIONNEMENT PACKAGING	Emballage individuel ou par 10 / Individual pack or per 10					

0,405m<sup>2</sup>/X  
X  
X

N.30

# HI-WAY

7HWGY / 7HWGO



## AVANTAGES / BENEFITS

- FONCTIONNEL: nombreuses poches + réversible
- AJUSTABLE: serrage bas
- FUNCTIONAL: many pockets + reversible
- ADJUSTABLE: low tightening



7HWGY



7HWGO

## TISSUS / FABRICS

- FACE FLUO: OXFORD 100% Polyester enduit Polyuréthane - 150D
- FACE GRISE: 100% Polyester pongé enduit PVC - 250g/m<sup>2</sup>
- MATELASSAGE: 100% Polyester - 140g/m<sup>2</sup>
- BANDES RÉTRO-RÉFLÉCHISSANTES: Bandes cousues microbilles : 5cm
- FLUO SIDE: OXFORD 100% Polyester, Polyurethane coated - 150D
- GREY SIDE: 100% Polyester pongee, PVC coated - 250g/m<sup>2</sup>
- PADDING: 100% Polyester - 140g/m<sup>2</sup>
- RETRO-REFLECTIVE BANDS: sewn microbead bands : 5cm

## CARACTÉRISTIQUES / FEATURES

- Col officier
- Zip central
- Bas réglable par cordon élastique & bloqueurs
- 2 FACES: 2 poches basses sous rabat + scratch
- 2 FACES: 1 poche téléphone
- 2 FACES: 1 poche poitrine zippée
- 2 FACES: 1 poche poitrine sous rabat + scratch
- Protège reins
- Bandes cousues : 2 ceintures
- NB lavages : 20
- Mandarin collar
- Central zipper
- Adjustable hemline with elastic drawstring & blockers
- 2 SIDES: 2 lower pockets under flap + velcro
- 2 SIDES: 1 phone pocket
- 2 SIDES: 1 zipped chest pocket
- 2 SIDES: 1 chest pocket under flap + velcro
- Kidney protection
- Sewn bands: 2 belts
- NB washes: 20

TAILLES SIZES	M	L	XL	2XL	3XL
JAUNE HV / GRIS HV YELLOW / GREY	7HWGYM	7HWGYL	7HWGYXL	7HWGYXXL	7HWGYXXXL
ORANGE HV / GRIS HV ORANGE / GREY	7HWGOM	7HWGOL	7HWGOXL	7HWGOXXL	7HWGOXXXL
CONDITIONNEMENT PACKAGING	Emballage individuel ou par 10 / Individual pack or per 10				



EN 20471



# HI-WAY

MO70510 / MO70500



## AVANTAGES / BENEFITS

- CONFORT: dos ultra rallongé + polaire sur la face contrastée
- PRATIQUE: réversible
- VISIBLE: bandes épaules pour être perçu penché ou avec une vue de dessus
- COMFORT: ultra long back + fleece on the contrasting side
- PRACTICAL: reversible
- VISIBLE: shoulder bands to be perceived leaning or with an overhead view



MO70500

MO70510

## TISSUS / FABRICS

- FACE FLUO: OXFORD 100% Polyester enduit Polyuréthane - 300D
- FACE NOIRE: POLAIRE 100% Polyester - 280g/m<sup>2</sup>
- FLUO SIDE: OXFORD 100% Polyester, Polyurethane coated - 300D
- BLACK SIDE: FLEECE 100% Polyester - 280g/m<sup>2</sup>
- BANDES RÉTRO-RÉFLÉCHISSANTES: Bandes cousues microbilles : 5cm
- RETRO-REFLECTIVE BANDS: sewn microbead bands: 5cm

## CARACTÉRISTIQUES / FEATURES

- Col montant contrasté
- Zip central
- Ceinture élastiquée côtés
- 2 FACES: 2 poches basses sous passepoil
- FACE FLUO: 1 poche poitrine zippée sous passepoil
- Col contrasté
- Protège reins
- Bandes cousues: 2 bretelles + 2 ceintures
- NB lavages : 20
- Contrasted high collar
- Central zipper
- Elasticated waistband on sides
- 2 SIDES: 2 lower pockets under piping
- FLUO SIDE: 1 chest pocket with zip under piping
- Contrasting collar
- Kidney protection
- Sewn bands: 2 straps + 2 belts
- NB washes: 20

TAILLES SIZES	M	L	XL	2XL	3XL
ORANGE HV / NOIR HV ORANGE / BLACK	70510	70511	70512	70513	70514
JAUNE HV / NOIR HV YELLOW / BLACK	70500	70501	70502	70503	70504
CONDITIONNEMENT PACKAGING	Emballage individuel ou par 10 / Individual pack or per 10				



EN 20471



# YORU

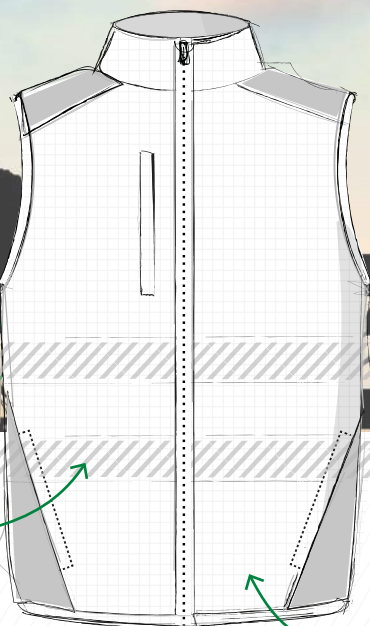

Bandes segmentées  
Segmented bands

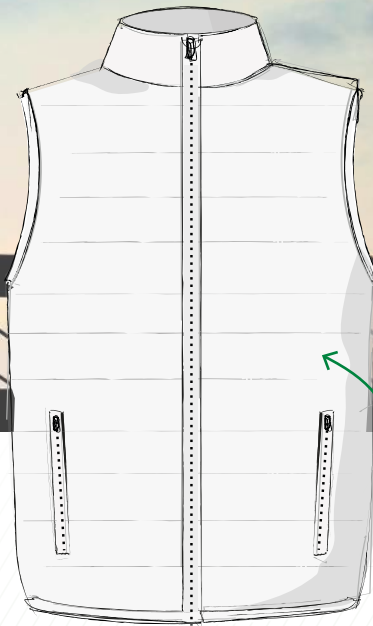

Tissu brossé  
Brushed fabric

Ripstop enduit  
Ripstop coated



**REVERSIBLE =  
FONCTIONNEL**  
REVERSIBLE =  
FUNCTIONAL

Idéal pour conserver une bonne température corporelle et sans gêner la liberté de mouvement le gilet est devenu un incontournable. Utilisation polyvalente selon la face extérieure choisie.

*Ideal for keeping a good body temperature and without disturbing the freedom of movement, the bodywarmer has become a must-have. Multipurpose use depending on the chosen outer face*



**FOCUS / FOCUS**



**RIPSTOP ENDUIT = ROBUSTESSE**  
Augmente la résistance au déchirement.  
Si des déchirures sont déjà amorcées elles sont stoppées par les fils plus épais formant le « carré »

**COATED RIPSTOP = ROBUSTNESS**  
*Increases tear resistance.  
If tears have already started, they are stopped by the thicker threads forming the «square».*



**BANDES SEGMENTÉES = CONFORT**  
Les bandes thermocollées segmentées apportent **souplesse, respirabilité et anti-irritations** (sur la face peau)

**SEGMENTED BANDS = COMFORT**  
*Segmented thermofused bands provide **flexibility, breathability and anti-irritation** (on skin side)*



**TISSU BROSSÉ = DOUCEUR**  
C'est un atout supplémentaire pour se protéger du froid tout en étant confortable

**BRUSHED FABRIC = SOFTNESS**  
*It's an additional asset to protect yourself from the cold while being comfortable*

# YORU

5YOR160 / 5YOR170



## AVANTAGES / BENEFITS

- **ROBUSTE:** matière Ripstop sur la face fluo
- **CONFORT:** bandes segmentées + maille brossée sur face bleue
- **PRATIQUE:** réversible
- **ROBUST:** Ripstop material on the fluorescent side
- **COMFORT:** segmented bands + brushed mesh on blue side
- **PRACTICAL:** reversible



5YOR160



5YOR170

## TISSUS / FABRICS

- **FACE FLUO :** RIPSTOP 100% Polyester enduit Polyuréthane - 200g/m<sup>2</sup>
- **FACE MARINE :** 100% Polyester brossé - 125g/m<sup>2</sup>
- **MATELASSAGE :** 100% Polyester - 140g/m<sup>2</sup>
- **IMPERMÉABILITÉ :** 1 000 mm
- **BANDES RÉTRO-RÉFLÉCHISSANTES:** Bandes segmentées microbilles : 6cm

- **FLUO FACE:** RIPSTOP 100% Polyester, PU coated - 200g/m<sup>2</sup>
- **NAVY FACE:** 100% Polyester brushed - 125g/m<sup>2</sup>
- **PADDING:** 100% Polyester - 140g/m<sup>2</sup>
- **WATERPROOFNESS :** 1 000 mm
- **RETRO-REFLECTIVE BANDS:** segmented microbead bands : 6cm

## CARACTÉRISTIQUES / FEATURES

- Col montant
- Zip central
- Biais élastiqués sur emmanchures + bas
- **FACE FLUO :** 1 poche poitrine zippée sous passepoil
- **2 FACES :** 2 poches basses zippées sous passepoil
- Empiècements épaules + côtés antisalissure
- Bandes segmentées : 2 ceintures

- High collar
- Central zip
- Elasticated bias on armholes + bottom
- **FLUO SIDE:** 1 zipped chest pocket under piping
- **2 SIDES:** 2 lower zipped pockets under piping
- Antifouling shoulder + side yokes
- Segmented bands : 2 belts

TAILLES SIZES	S	M	L	XL	2XL	3XL
<b>JAUNE HV / MARINE</b> HV YELLOW / NAVY BLUE	5YOR16000S	5YOR16000M	5YOR16000L	5YOR1600XL	5YOR1602XL	5YOR1603XL
<b>ORANGE HV / MARINE</b> HV ORANGE / NAVY BLUE	5YOR17000S	5YOR17000M	5YOR17000L	5YOR1700XL	5YOR1702XL	5YOR1703XL
<b>CONDITIONNEMENT</b> PACKAGING	Emballage individuel ou par 10 / Individual pack or per 10					





MAX.GR.  
ARE

20.480 KGS  
45.200 LBS  
2.160 KGS  
4.760 LBS

NET  
U.CAP.

20 KGS  
40 LBS  
2.160 KGS  
4.760 LBS



# TEMPS PLUVIEUX

**RAINY** WEATHER

# HOTARU

5HOT17\* / 5HOT16\*



## AVANTAGES / BENEFITS

- LÉGÈRE: 2 couches
- PERFORMANTE: membrane haute performance imper-respirante
- CONFORT: bandes segmentées + doublure mesh
- MODERNE: coupe ajustée
- LIGHT: 2 layers
- PERFORMANCE: high performance waterproof-breathable membrane
- COMFORT: segmented bands + mesh lining
- MODERN: slim fit



5HOT17



5HOT16



HOTARU FR



HOTARU EN

## TISSUS / FABRICS

- SOFTSHELL 2 COUCHES : 100% Polyester stretch mécanique + Membrane TPU - 100g/m<sup>2</sup>
- DOUBLURE MESH : 100% Polyester - 80g/m<sup>2</sup> (corps + manches)
- DOUBLURE TAFFETAS : 100% Polyester - 55g/m<sup>2</sup> (capuche + poches)
- IMPERMÉABILITÉ : 8 000 mm
- RESPIRABILITÉ : 5 000 g/m<sup>2</sup>/24h
- BANDES RÉTRO-RÉFLÉCHISSANTES: Bandes segmentées microbilles : 5cm
- 2-LAYER SOFTSHELL: 100% Polyester mechanical stretch + TPU membrane - 100g/m<sup>2</sup>
- MESH LINING: 100% Polyester - 80g/m<sup>2</sup> (body + sleeves)
- TAFFETA LINING: 100% Polyester - 55g/m<sup>2</sup> (hood + pockets)
- WATERPROOFNESS : 8 000 mm
- BREATHABILITY : 5 000 g/m<sup>2</sup>/24h
- RETRO-REFLECTIVE BANDS: Segmented microbead bands : 5cm

## CARACTÉRISTIQUES / FEATURES

- Coutures étanchées
- Capuche tempête fixe intégrée dans le col
- Capuche réglable par scratch + cordon de serrage élastique & bloqueurs
- Col montant
- Protège menton
- Zip central sous rabat à scratches
- Poignets semi-élastiqués + Patte de serrage à scratch
- Bas réglable par cordon élastique & bloqueurs
- 1 poche poitrine zippée sous passepoil
- 2 poches basses zippées sous passepoil
- 1 poche manche zippée sous passepoil
- 1 poche basse plaquée intérieure zippée
- Coupe Ajustée
- Bandes segmentées: 2 ceintures + 2 brassards/manche
- Trappe de marquage
- Taped seams
- Fixed storm hood integrated in the collar
- Adjustable hood with velcro + elastic drawstring & blockers
- High collar
- Chin protection
- Central zip under flap with velcro
- Semi-elasticated cuffs + Velcro tabs
- Adjustable hemline with elastic drawstring & blockers
- 1 chest pocket with zip under Oxford piping
- 2 lower zipped pockets under piping
- 1 zipped sleeve pocket under piping
- 1 inside patch pocket with zip
- Slim fit
- Segmented bands: 2 belts + 2 armbands/sleeve
- Marking access

TAILLES SIZES	S	M	L	XL	2XL	3XL	4XL
ORANGE HV / MARINE* HV ORANGE / NAVY BLUE*	5HOT17000S	5HOT17000M	5HOT17000L	5HOT1700XL	5HOT172XL	5HOT1703XL	5HOT1704XL
JAUNE HV / MARINE* HV YELLOW / NAVY BLUE*	5HOT16000S	5HOT16000M	5HOT16000L	5HOT1600XL	5HOT1602XL	5HOT1603XL	5HOT1604XL
CONDITIONNEMENT PACKAGING	Emballage individuel ou par 10 / Individual pack or per 10						



EN 20471  
S+M



EN 20471  
L+



EN 343

\* Dans la limite des stocks disponibles / Within the limit of the available stock



# MIX AND MATCH



## → Bénéfices de l'association des 2 produits

*Benefits of combining the 2 products*

- Souplesse et légèreté
- Isolation thermique
- Résistance aux intempéries
- Solidité

- Flexibility and lightness
- Thermal insulation
- Weather resistance
- Strength



### **HOTARU** 5HOT16 / 5HOT17

Veste de pluie softshell HV  
*HV softshell rain jacket*

### **YORU** 5YOR160 / 5YOR170

Gilet de froid Ripstop HV  
*Ripstop HV Cold waistcoat*



ou / or



### — Veste par-dessus le gilet froid

- Usage climats frais / pluvieux / venteux
- Aisance des mouvements

*Jacket over cold waistcoat*

- Use in cool / rainy / windy climates
- Ease of movement

### — Gilet froid par-dessus la veste

- Usage climat frais / venteux
- Contre les risques d'abrasion

*Cold waistcoat over the jacket*

- Cool / windy climate use
- Against the risk of abrasion



# SANGAKU



Capuche tempête  
Storm hood

Ripstop laminé  
Laminated ripstop

Doublure mesh  
Mesh lining



Poignet ajustables  
par scratch  
Adjustable cuffs by  
Velcro

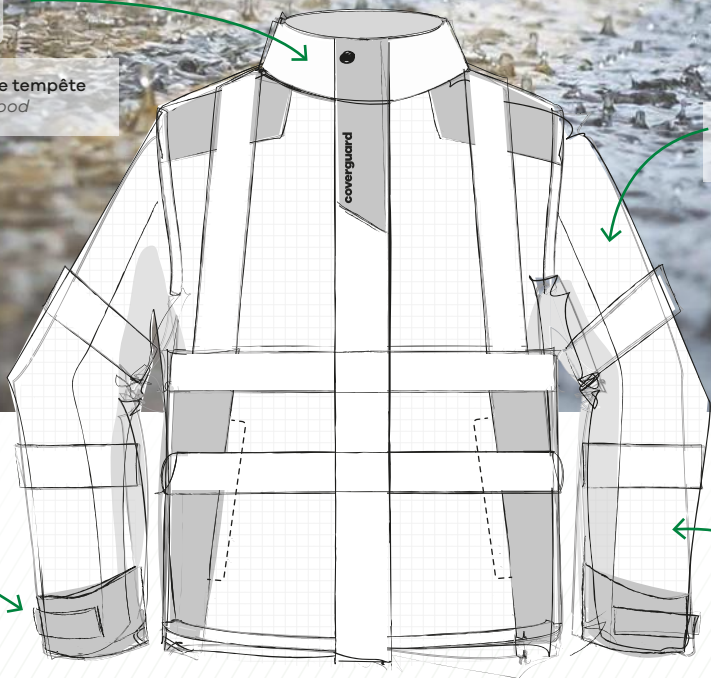

## IMPERMÉABILITÉ WATERPROOFNESS

Tissu  
extérieur  
Outer  
fabric

Membrane  
Membrane

Doublure  
Lining

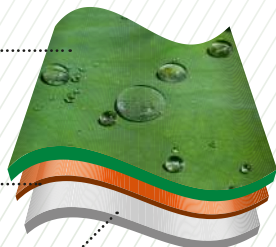

La membrane et les coutures étanchées sont  
des éléments qui permettent de rester au sec.  
Membrane and taped seams keep you dry.



## FOCUS / FOCUS



RIPSTOP LAMINÉ = ROBUSTESSE  
LAMINATED RIPSTOP = ROBUSTNESS

Augmente la résistance au déchirement. Si des  
déchirures sont déjà amorcées elles sont stoppées  
par les fils plus épais formant le « carré ».

Increases tear resistance. If tears have already  
started, they are stopped by the thicker threads  
forming the «square».



MESH = RESPIRABILITÉ  
MESH = BREATHABILITY

Le flux d'air est permis à travers les alvéoles  
de la maille ajourée permettant un confort pour  
le porteur.

Air flow is allowed through the open mesh cells  
allowing comfort for the wearer.



COMBINABLE / COMBINABLE

Un deuxième zip est intégré à la coque afin d'y  
glisser une des vestes adaptées en guise de  
doublure.

1 climat = 1 protection

A second zip is integrated in the shell insert one  
of the adapted jackets as a lining.  
1 climate = 1 protection



# SANGAKU

5SAN16 / 5SAN17



## AVANTAGES / BENEFITS

- **ROBUSTE:** Ripstop et Oxford 300D
- **IMPERMÉABLE:** membrane 8 000mm
- **ANTISALISSURE:** coloris contrasté aux entrées de poches
- **COMBINABLE:** Les produits KAZAN (veste et softshell) peuvent être associés pour former un produit hiver
- **ROBUST:** Ripstop and Oxford 300D
- **WATERPROOF:** 8 000mm membrane
- **ANTI FOULING:** contrasting colors at pocket entries
- **COMBINABLE:** KAZAN products (jacket and softshell) can be combined to form a winter product



5SAN16



5SAN17



SANGAKU FR



SANGAKU EN

## TISSUS / FABRICS

- **RIPSTOP OXFORD:** 100% Polyester - 300D + Membrane PU
- **DOUBLURE MESH:** 100% Polyester - 75g/m<sup>2</sup>
- **IMPERMÉABILITÉ:** 8 000 mm
- **RESPIRABILITÉ:** 5 000 g/m<sup>2</sup>/24h
- **BANDES RÉTRO-RÉFLÉCHISSANTES:** Bandes cousues microbilles: 5cm
- **RIPSTOP OXFORD:** 100% Polyester - 300D + PU Membrane
- **MESH LINING:** 100% Polyester - 75g/m<sup>2</sup>
- **WATERPROOFNESS:** 8 000 mm
- **BREATHABILITY:** 5 000 g/m<sup>2</sup>/24h
- **RETRO-REFLECTIVE BANDS:** sewn microbead bands: 5cm

## CARACTÉRISTIQUES / FEATURES

- Coutures étanchées
- Capuche tempête intégrée dans le col + cordon de serrage élastique
- Col montant
- Zip central à double curseur sous rabat à scratchs
- Protège menton
- Poignets réglables par scratch
- Bas réglables par cordons élastiques
- 2 poches basses zippées sous passepoil
- 1 poche Napoléon + porte badge amovible
- 2 poches plaquées intérieures fermées par scratch
- Empiècements contrastés : Épaules + Côtés + Poignets
- Zips + attaches pour fixation de la veste ou softshell KAZAN
- 1 boucle passe écouteur intérieure
- Bandes cousues: 2 bretelles + 2 ceintures + 2 brassards/manche
- Accès pour marquage
- NB lavages : 25
- Taped seams
- Storm hood integrated into collar + elastic drawcord
- High collar
- Central two-way zip under flap with velcro
- Chin guard
- Adjustable cuffs by velcro
- Adjustable hemline with elastic drawcord
- 2 lower zipped pockets under piping
- 1 Napoleon pocket + removable badge holder
- 2 inside patch pockets closed by velcro
- Contrasting yokes: Shoulders + Sides + Cuffs
- Zippers + fasteners for attaching the KAZAN jacket or softshell
- 1 earphone loop inside
- Sewn bands: 2 straps + 2 belts + 2 armbands/sleeve
- Branding access
- NB washes: 25

TAILLES / SIZES	S	M	L	XL	2XL	3XL
JAUNE HV / MARINE HV YELLOW / NAVY BLUE	5SAN16000S	5SAN16000M	5SAN16000L	5SAN1600XL	5SAN1602XL	5SAN1603XL
ORANGE HV / MARINE HV ORANGE / NAVY BLUE	5SAN17000S	5SAN17000M	5SAN17000L	5SAN1700XL	5SAN1702XL	5SAN1703XL
CONDITIONNEMENT / PACKAGING	Emballage individuel ou par 10 / Individual pack or per 10					



EN 20471



EN 343



# KAZAN

5KAP170 / 5KAP160



## AVANTAGES / BENEFITS

- IMPER-RESPIRANTE: 8 000mm - 5 000g/m<sup>2</sup>/24h
- FONCTIONNELLE: Capuche repliable + poignets coupe-vent
- COMBINABLE: Les produits KAZAN (veste et softshell) peuvent être associés pour former un produit hiver
- LARGE GRILLE DE TAILLE: S au 4XL
- WATERPROOF: 8 000mm - 5 000g/m<sup>2</sup>/24h
- FUNCTIONAL: Foldable hood + windproof cuffs
- COMBINABLE: KAZAN products (jacket and softshell) can be combined to form a winter product
- LARGE SIZE GRID: S to 4XL



5KAP170



5KAP160



KAZAN FR



KAZAN EN

## TISSUS / FABRICS

- OXFORD : 100% Polyester enduit Polyuréthane - 300D
- DOUBLURE MESH : 100% Polyester - 75g/m<sup>2</sup> (corps)
- DOUBLURE TAFFETAS : 100% Polyester - 60g/m<sup>2</sup> (manches)

- IMPERMÉABILITÉ : 8 000 mm
- RESPIRABILITÉ : 5 000 g/m<sup>2</sup>/24h

- BANDES RÉTRO-RÉFLÉCHISSANTES : Bandes cousues microbilles : 5cm

- OXFORD : 100% Polyester, Polyurethane coated - 300D
- MESH LINING : 100% Polyester - 75g/m<sup>2</sup> (body)
- TAFFETA LINING : 100% Polyester - 60g/m<sup>2</sup> (sleeves)

- WATERPROOFNESS : 8 000 mm
- BREATHABILITY : 5 000 g/m<sup>2</sup>/24h

- RETRO-REFLECTIVE BANDS: sewn microbead bands: 5cm

## CARACTÉRISTIQUES / FEATURES

- Coutures étanchées
- Capuche fixe intégrée dans le col + Cordon de serrage
- Col montant
- Zip central à double curseur sous rabat à scratchs + 2 pressions
- Poignets réglables par scratch
- 2 poches basses sous rabat fermé par scratchs
- 1 poche Napoléon zippée sous rabat central
- 1 poche plaquée intérieure fermée par scratch
- Empiècements contrastés : Épaules + Bas + Poignets
- Zip + attaches pour fixation de la veste ou softshell KAZAN
- Bandes cousues: 2 bretelles + 2 ceintures + 2 brassards/manche
- Trappe de marquage

- Taped seams
- Fixed hood integrated into collar + drawstring
- High collar
- Central zipper with double slider under velcro flap + 2 snaps
- Adjustable cuffs by velcro
- 2 lower pockets under flap closed by velcros
- 1 Napoleon pocket under central tab
- 1 inside patch pocket closed by velcro
- Contrasting yokes: Shoulders + Bottom + Cuffs
- Zipper + fasteners for attaching the KAZAN jacket or softshell
- Sewn bands: 2 straps + 2 belts + 2 armbands/sleeve
- Marking access

TAILLES SIZES	S	M	L	XL	2XL	3XL	4XL
ORANGE HV / MARINE HV ORANGE / NAVY BLUE	5KAP17000S	5KAP17000M	5KAP17000L	5KAP1700XL	5KAP1702XL	5KAP1703XL	5KAP1704XL
JAUNE HV / MARINE HV YELLOW / NAVY BLUE	5KAP16000S	5KAP16000M	5KAP16000L	5KAP1600XL	5KAP1602XL	5KAP1603XL	5KAP1604XL
CONDITIONNEMENT PACKAGING	Emballage individuel ou par 10 / Individual pack or per 10						



EN 20471



EN 343





# HYDRA

5HYJ16 / 5HYJ17



## AVANTAGES / BENEFITS

- PROTECTION: Capuche dans le col
- CONFORT ET RESPIRABILITÉ: doublure en mesh
- RÉSISTANCE ET IMPERMÉABILITÉ: Oxford enduit PU
- PROTECTION: Hood in collar
- COMFORT AND BREATHABILITY: mesh lining
- RESISTANCE AND WATERPROOFNESS: PU coated Oxford



5HYJ16



5HYJ17

## TISSUS / FABRICS

- OXFORD : 100% Polyester enduit Polyuréthane - 300D
- DOUBLURE MESH : 100% Polyester - 75g/m<sup>2</sup>

■ IMPERMÉABILITÉ : 3 000 mm

- BANDES RÉTRO-RÉFLÉCHISSANTES : Bandes cousues microbilles : 5cm

- OXFORD : 100% Polyester, Polyurethane coated - 300D
- MESH LINING : 100% Polyester - 75g/m<sup>2</sup>

■ WATERPROOFNESS : 3 000 mm

- RETRO-REFLECTIVE BANDS: sewn microbead bands: 5cm

## CARACTÉRISTIQUES / FEATURES

- Coutures étanchées
- Capuche tempête en Oxford fixe intégrée dans le col + Visière
- Capuche avec cordon de serrage élastiqué & bloqueurs
- Col montant
- Zip central sous rabat à pressions
- Poignets semi-élastiqués + Patte de serrage à scratch
- Ceinture + Bas réglables par cordons élastiques & bloqueurs
- 2 poches basses sous rabat fermé par scratchs
- 2 poches repose-mains
- 1 poche poitrine à soufflet + rabat fermé par scratch
- Empiècements contrastés : Épaules + Bas + Poignets
- Ventilation indirecte sous empiècements devant et dos
- Cèllets d'aération sous les aisselles
- Bandes cousues : 2 bretelles + 2 ceintures + 2 brassards/manche
- Trappe de marquage
- NB lavages : 20

- Taped seams
- Fixed storm hood integrated in the collar + Visor
- Hood with elasticated drawstring & blockers
- High collar
- Central zip under snap flap
- Semi-elasticated cuffs + Velcro tabs
- Adjustable waistband+ hemline with elastic drawstrings & blockers
- 2 lower pockets under flap closed by velcro
- 2 hand rest pockets
- 1 gusseted chest pocket + flap closed by velcro
- Contrasting yokes: Shoulders + Bottom + Cuffs
- Indirect ventilation under front and back yokes
- Underarm ventilation eyelets
- Sewn bands: 2 straps + 2 belts + 2 armbands/sleeve
- Marking access
- NB washes: 20

TAILLES SIZES	S	M	L	XL	2XL	3XL
<b>JAUNE HV / MARINE</b> HV YELLOW / NAVY BLUE	5HYJ16000S	5HYJ16000M	5HYJ16000L	5HYJ16000XL	5HYJ1602XL	5HYJ1603XL
<b>ORANGE HV / MARINE</b> HV ORANGE / NAVY BLUE	5HYJ17000S	5HYJ17000M	5HYJ17000L	5HYJ17000XL	5HYJ1702XL	5HYJ1703XL
<b>CONDITIONNEMENT</b> PACKAGING	Emballage individuel ou par 10 / Individual pack or per 10					



EN 20471



EN 343

# HYDRA

5HYP16 / 5HYP17



## AVANTAGES / BENEFITS

- IMPERMÉABLE: Oxford enduit + coutures étanchées
- FONCTIONNEL: bretelles amovibles élastiquées + braguette
- AJUSTABLE: taille élastiquée + cheville réglable
- WATERPROOF: coated Oxford + taped seams
- FUNCTIONAL: removable elasticated straps + fly
- ADJUSTABLE: elastic waist + adjustable ankle

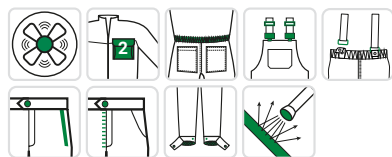

5HYP16



5HYP17

## TISSUS / FABRICS

- OXFORD : 100% Polyester enduit Polyuréthane - 300D
- IMPERMÉABILITÉ : 3 000 mm
- BANDES RÉTRO-RÉFLÉCHISSANTES : Bandes cousues microbilles : 7cm

- OXFORD : 100% Polyester, Polyurethane coated - 300D
- WATERPROOFNESS : 3 000 mm
- RETRO-REFLECTIVE BANDS: sewn microbead bands : 7cm

## CARACTÉRISTIQUES / FEATURES

- Coutures étanchées
- Braguette à pression
- Taille élastiquée
- Fentes passe-main
- Bas de jambes réglable par pression
- Empiècements contrastés : chevilles
- Bretelles élastiques amovibles
- Bandes cousues : 2 brassards/jambe
- NB lavages : 20

- Taped seams
- Snap fly
- Elasticated waistband
- Hand pass slits
- Adjustable lower legs by snap
- Contrasting yokes: ankles
- Removable elastic straps
- Sewn bands: 2 armbands/leg
- NB washes: 20

TAILLES SIZES	S	M	L	XL	2XL	3XL
JAUNE HV / MARINE HV YELLOW / NAVY BLUE	5HYP16000S	5HYP16000M	5HYP16000L	5HYP1600XL	5HYP1602XL	5HYP1603XL
ORANGE HV / MARINE HV ORANGE / NAVY BLUE	5HYP17000S	5HYP17000M	5HYP17000L	5HYP1700XL	5HYP1702XL	5HYP1703XL
CONDITIONNEMENT PACKAGING	Emballage individuel ou par 10 / Individual pack or per 10					



EN 343



PARKA / PARKA

TEMPS PLUVIEUX / RAINY WEATHER

# HARBOR

MO70330\* / MO70310\*



## AVANTAGES / BENEFITS

- SOUPLE ET IMPERMÉABLE: maille enduite PU + coutures soudées
- ANTISALISSURE: larges empiècements contrastés
- FLEXIBLE AND WATERPROOF: PU coated mesh + welded seams
- ANTIFOULING: large contrasting inserts



MO70330



MO70310

## TISSUS / FABRICS

- EXTÉRIEUR : 100% Polyester enduit Polyuréthane - 170g/m<sup>2</sup>
- BANDES RÉTRO-RÉFLÉCHISSANTES: Bandes en transfert microbilles : 5cm
- SHELL: 100% Polyester, Polyurethane coated - 170g/m<sup>2</sup>
- RETRO-REFLECTIVE BANDS: microbead transfer bands: 5cm

## CARACTÉRISTIQUES / FEATURES

- Coutures soudées
- Capuche fixe intégrée dans le col + Cordon de serrage élastique & bloqueurs
- Col montant
- Zip central sous rabat à pressions
- Poignets élastiqués
- 2 poches basses soudées à rabat + 2 pressions
- Empiècements contrastés : Bas + Poignets
- Bandes en transfert: 2 bretelles + 2 ceintures + 2 brassards/manche
- NB lavages : 20
- Welded seams
- Fixed hood into collar + elastic drawstring & blockers
- High collar
- Central zip under snap flap
- Elasticated cuffs
- 2 welded lower pockets with flap + 2 snaps
- Contrasting yokes: Bottom + Cuffs
- Transfer bands: 2 straps + 2 belts + 2 armbands/sleeve
- NB washes: 20

TAILLES SIZES	M	L	XL	2XL
ORANGE HV / MARINE* HV ORANGE / NAVY BLUE*	-	70331	70332	-
JAUNE HV / MARINE* HV YELLOW / NAVY BLUE*	70310	70311	70312	70313
CONDITIONNEMENT PACKAGING	Emballage individuel ou par 10 / Individual pack or per 10			



EN 343

# HARBOR

MO70340\* / MO70320\*



## AVANTAGES / BENEFITS

- SOUPLE ET IMPERMÉABLE: maille enduite PU + coutures soudées
- ANTISALISSURE: larges empiècements contrastés
- CONFORT: bretelles élastiquées
- FLEXIBLE AND WATERPROOF: PU coated mesh + welded seams
- ANTIFOULING: large contrasting inserts
- COMFORT: elasticated straps



MO70340



MO70320

## TISSUS / FABRICS

- EXTÉRIEUR : 100% Polyester enduit Polyuréthane - 170g/m<sup>2</sup>
- BANDES RÉTRO-RÉFLÉCHISSANTES: Bandes en transfert microbilles : 7cm
- SHELL: 100% Polyester, Polyurethane coated - 170g/m<sup>2</sup>
- RETRO-REFLECTIVE BANDS: microbead transfer bands: 7cm

## CARACTÉRISTIQUES / FEATURES

- Coutures soudées
- Taille élastiquée + Cordon de serrage & bloqueurs
- Bas de jambes réglables par pression
- Empiècements contrastés : chevilles
- Bretelles élastiques amovibles sur le devant
- Bandes en transfert : 2 brassards/jambe
- NB lavages : 20
- Welded seams
- Elasticated waistband + Drawstrind & blockers
- Adjustable lower legs by snap
- Contrasting yokes: ankles
- Removable elastic straps on front
- Transfer bands: 2 armbands/leg
- NB washes: 20

TAILLES SIZES	M	L	XL	2XL
ORANGE HV / MARINE* HV ORANGE / NAVY BLUE*	70340	70341	70342	70343
JAUNE HV / MARINE* HV YELLOW / NAVY BLUE*	70320	70321	70322	-
CONDITIONNEMENT PACKAGING	Emballage individuel ou par 10 / Individual pack or per 10			

\* Dans la limite des stocks disponibles / Within the limit of the available stock





MANTEAU / COAT

TEMPS PLUVIEUX / RAINY WEATHER

# KAWA COAT

5KWC160\* / 5KWC170\*



## AVANTAGES / BENEFITS

- UN ESSENTIEL: manteau long HV
- IMPER-RESPIRABILITÉ MAXIMUM: normé EN 343:4.4
- RÉSISTANT: Oxford
- AN ESSENTIAL: HV long coat
- MAXIMUM WATERPROOFNESS: according to EN 343:4.4
- RESISTANT: Oxford



5KWC160



5KWC170



## TISSUS / FABRICS

- OXFORD : 100% Polyester enduit Polyuréthane - 150D
- BANDES RÉTRO-RÉFLÉCHISSANTES: Bandes cousues microbilles: 5cm
- OXFORD : 100% Polyester, Polyurethane coated - 150D
- RETRO-REFLECTIVE BANDS: sewn microbead bands: 5cm

## CARACTÉRISTIQUES / FEATURES

- Coutures étanchées
- Capuche fixe intégrée dans col zippé + Cordon de serrage
- Col montant
- Zip central sous rabat à pressions
- Manches raglan
- Poignets coupe-vent élastiqués
- 2 poches basses à rabat
- Dos ventilé
- Œillets d'aération sous les aisselles
- Longueur: 120cm
- Bandes cousues : 2 ceintures + 2 brassards/manche
- Taped seams
- Fixed hood with zip collar + drawstring
- High collar
- Central zip under snap flap
- Raglan sleeves
- Elasticated windproof cuffs
- 2 lower pockets with flaps
- Vented back
- Underarm ventilation eyelets
- Length: 120cm
- Sewn bands: 2 belts + 2 armbands/sleeve

TAILLES SIZES	S	M	L	XL	2XL	3XL
JAUNE HV* HV YELLOW*	5KWC16000S	5KWC16000M	5KWC16000L	5KWC1600XL	5KWC1602XL	5KWC1603XL
ORANGE HV* HV ORANGE*	5KWC17000S	5KWC17000M	5KWC17000L	5KWC1700XL	5KWC1702XL	5KWC1703XL
CONDITIONNEMENT PACKAGING	Emballage individuel ou par 10 / Individual pack or per 10					



EN 343

\* Dans la limite des stocks disponibles / Within the limit of the available stock



## KAWA

5KAW160 / 5KAW170



## AVANTAGES / BENEFITS

- INCONTOURNABLE: un par-dessus simple et efficace
- IMPER-RESPIRABILITÉ ÉLEVÉE: performance maximale de la norme EN343
- RÉSISTANT : Oxford 150D
- AJUSTABLE : serrage ceinture + pressions bas de jambes
- INCONTOURNABLE: a simple and effective overlay
- HIGH WATERPROOFNESS: maximum performance of the EN343 standard
- RESISTANT: Oxford 150D
- ADJUSTABLE: belt tightening + leg press studs



5KAW160



5KAW170

## TISSUS / FABRICS

- OXFORD : 100% Polyester enduit Polyuréthane - 150D
- BANDES RÉTRO-RÉFLÉCHISSANTES : Bandes cousues microbilles : 5 cm

- OXFORD: 100% Polyester, Polyurethane coated - 150D
- RETRO-REFLECTIVE BANDS: sewn microbead bands: 5cm

## CARACTÉRISTIQUES / FEATURES

## VESTE / JACKET

- Coutures étanchées
- Capuche fixe intégrée dans col zippé + Cordon de serrage
- Col montant
- Zip central sous rabat à pressions
- Manches raglans
- Poignets coupe-vent
- Poignets ajustables par pression
- Serrage bas par cordon
- 2 poches basses à rabat
- Dos ventilé
- Cèllets d'aération sous les aisselles
- Bandes cousues : 2 ceintures + 2 brassards/manche

- Taped seams
- Fixed hood with zip collar + drawstring
- High collar
- Central zip under snap flap
- Raglan sleeves
- Elasticated cuffs inside
- Adjustable cuffs by snaps
- Adjustable hemline with drawstring
- 2 lower pockets with flaps
- Vented back
- Underarm ventilation eyelets
- Sewn bands: 2 belts + 2 armbands/sleeve

## PANTALON / PANTS

- Coutures étanchées
- Taille élastiquée
- Fentes passe-main
- Bandes cousues: 2 brassards/jambe
- Bas de jambes réglable par pression

- Taped seams
- Elasticated waistband
- Hand pass slits
- Sewn bands: 2 armbands/leg
- Adjustable lower legs by snap

TAILLES SIZES	S	M	L	XL	2XL	3XL
JAUNE HV HV YELLOW	5KAW16000S	5KAW16000M	5KAW16000L	5KAW1600XL	5KAW1602XL	5KAW1603XL
ORANGE HV HV ORANGE	5KAW17000S	5KAW17000M	5KAW17000L	5KAW1700XL	5KAW1702XL	5KAW1703XL
CONDITIONNEMENT PACKAGING	Emballage individuel ou par 10 / Individual pack or per 10					

CE

EN 20471  
Pantalon /  
PantsEN 20471  
Ensemble / Set  
Veste / Jacket

EN 343



# HI-WAY

7HWRO / 7HWRY



## AVANTAGES / BENEFITS

- **RÉSISTANCE ET IMPERMÉABILITÉ:**  
Oxford 300D enduit
- **ANTISSLISSURE:** empiecements contrastés
- **FONCTIONNEL:** capuche + serrages
- **STRENGTH AND WATERPROOFNESS:**  
300D Oxford coated
- **ANTI FOULING:** contrasting inserts
- **FUNCTIONAL:** hood + tightenings



## TISSUS / FABRICS

- **OXFORD:** 100% Polyester enduit Polyuréthane - 150D
- **IMPERMÉABILITÉ:** 2 000 mm
- **BANDES RÉTRO-RÉFLÉCHISSANTES:** Bandes cousues microbilles: 5cm



7HWRO



7HWRY

- **OXFORD:** 100% Polyester, Polyurethane coated - 150D
- **WATERPROOFNESS:** 2 000 mm
- **RETRO-REFLECTIVE BANDS:** sewn microbead bands: 5cm

## CARACTÉRISTIQUES / FEATURES

### VESTE / JACKET

- Coutures étanchées
- Capuche fixe intégrée dans le col + Cordon de serrage
- Col montant
- Zip central sous rabat à scratchs
- Poignets élastiqués
- Bas réglable par cordon & bloqueurs
- 2 poches basses sous rabat fermé par scratch
- Empiecements contrastés : Bas + Poignets
- Bandes cousues : 2 ceintures + 2 brassards/manche
- NB lavages : 20

- *Taped seams*
- *Fixed hood integrated in the collar + drawstring*
- *High collar*
- *Central zip under velcro flap*
- *Elasticated cuffs*
- *Adjustable hemline with drawstring & blockers*
- *2 lower pockets under flap closed by velcro*
- *Contrasting yokes: Bottom + Cuffs*
- *Sewn bands: 2 belts + 2 armbands/sleeve*
- *NB washes: 20*

### PANTALON / PANTS

- Coutures étanchées
- Taille élastiquée
- Fentes passe-main
- Empiecements contrastés : chevilles
- Bas de jambes réglables par pression
- Bandes cousues: 2 brassards/jambe

- *Taped seams*
- *Elasticated waistband*
- *Hand pass slits*
- *Contrasting yokes: ankles*
- *Adjustable lower legs by snap*
- *Sewn bands: 2 armbands/leg*



**EN 20471**  
Pantalon /  
Trousers



**EN 20471**  
Ensemble / Set  
Veste / Jacket



**EN 343**  
Ensemble  
/ Set

TAILLES SIZES	S	M	L	XL	2XL	3XL
<b>ORANGE HV / MARINE</b> HV ORANGE / NAVY BLUE	7HWROS	7HWROM	7HWROL	7HWROXL	7HWROXXL	-
<b>JAUNE HV / MARINE</b> HV YELLOW / NAVY BLUE	7HWRY S	7HWRY M	7HWRY L	7HWRY XL	7HWRY XXL	7HWRY XXXL
<b>CONDITIONNEMENT</b> PACKAGING	Emballage individuel ou par 20 / Individual pack or per 20					





ENSEMBLE / SET

# HYDRA

7HYDY / 7HYDO

TEMPS PLUVIEUX / RAINY WEATHER



7HYDY



7HYDO

## AVANTAGES / BENEFITS

- CONFORT ET RESPIRABILITÉ: doublure en mesh
- RÉSISTANCE ET IMPERMÉABILITÉ: Oxford 300D enduit
- ANTISALISSURE: empiècements contrastés
- VISIBLE: bandes bretelles pour être vu à 360°C

- COMFORT AND BREATHABILITY: mesh lining
- STRENGTH AND WATERPROOFNESS: 300D coated Oxford
- ANTIFOULING: contrasting inserts
- VISIBLE: straps to be seen at 360°C



EN 20471  
Ensemble / Set



EN 343  
Ensemble / Set

TAILLES SIZES	S	M	L	XL	2XL	3XL
ORANGE HV / MARINE HV ORANGE / NAVY BLUE	7HYDYS	7HYDYM	7HYDYL	7HYDYXL	7HYDXXL	7HYDYXXXL
JAUNE HV / MARINE HV YELLOW / NAVY BLUE	7HYDOS	7HYDOM	7HYDOL	7HYDOXL	7HYDOXXL	7HYDOXXXL
CONDITIONNEMENT PACKAGING	Emballage individuel ou par 10 / Individual pack or per 10					

→ **Veste / Jacket**EN 20471  
Veste / Jacket**TISSUS / FABRICS**

- OXFORD : 100% Polyester enduit Polyuréthane - 300D
- DOUBLURE MESH : 100% Polyester - 75g/m<sup>2</sup>

---

- IMPERMÉABILITÉ : 3 000 mm

- BANDES RÉTRO-RÉFLÉCHISSANTES: Bandes cousues microbilles : 5cm

- OXFORD : 100% Polyester, Polyurethane coated - 300D
- MESH LINING : 100% Polyester - 75g/m<sup>2</sup>

---

- WATERPROOFNESS : 3 000 mm

- RETRO-REFLECTIVE BANDS: sewn microbead bands: 5cm

**CARACTÉRISTIQUES / FEATURES**

- Coutures étanchées
- Capuche tempête en Oxford fixe intégrée dans le col + Visière
- Capuche avec cordon de serrage élastiqué & bloqueurs
- Col montant
- Zip central sous rabat à pressions
- Poignets semi-élastiqués + Patte de serrage à scratch
- Ceinture + Bas réglables par cordons élastiques & bloqueurs
- 2 poches basses sous rabat fermé par scratchs
- 2 poches repose-mains
- 1 poche poitrine à soufflet + rabat fermé par scratch
- Empiècements contrastés : Épaules + Bas + Poignets
- Ventilation indirecte sous les empiècements devant et dos
- Cèllets d'aération sous les aisselles
- Bandes cousues : 2 bretelles + 2 ceintures + 2 brassards/manche
- Trappe de marquage
- NB lavages : 20

- Taped seams
- Fixed storm hood integrated in the collar + Visor
- Hood with elasticated drawstring & blockers
- High collar
- Central zip under snap flap
- Semi-elasticated cuffs + Velcro tab
- Adjustable waistband + hemline with elastic drawstrings & blockers
- 2 lower pockets under flap closed by velcro
- 2 hand rest pockets
- 1 gusseted chest pocket + flap closed by velcro
- Contrasting yokes: Shoulders + Bottom + Cuffs
- Indirect ventilation under front and back yokes
- Underarm ventilation eyelets
- Sewn bands: 2 straps + 2 belts + 2 armbands/sleeve
- Marking access
- NB washes: 20

→ **Pantalon / Pants**EN 20471  
Pantalon /  
Pants**TISSUS / FABRICS**

- OXFORD : 100% Polyester enduit Polyuréthane - 300D

- BANDES RÉTRO-RÉFLÉCHISSANTES: Bandes cousues microbilles : 5cm

- OXFORD : 100% Polyester, Polyurethane coated - 300D

- RETRO-REFLECTIVE BANDS: sewn microbead bands: 5cm

**CARACTÉRISTIQUES / FEATURES**

- Coutures étanchées
- Braguette à pression
- Taille élastiquée
- Fentes passe-main
- Empiècements contrastés : chevilles
- Bandes cousues: 2 brassards/jambe
- Bas de jambes réglable par pression

- Taped seams
- Snap fly
- Elasticated waistband
- Hand pass slits
- Contrasting yokes: ankles
- Sewn bands: 2 armbands/leg
- Adjustable lower legs by snap





# TEMPS CHAUD

**WARM** WEATHER



# SUNO

7SUNO / 7SUNY / 7SUNR



## AVANTAGES / BENEFITS

- PROTECTION: tissu avec une protection anti-UV (UPF 50+)
- RESPIRANT: bonne ventilation grâce aux aisselles en mesh
- CONFORT : les bandes segmentées apportent la souplesse
- ANTISSALISSURE: empiècements antissalissure dont au col
- PROTECTION: fabric with anti-UV protection (UPF 50+)
- BREATHABLE: good ventilation thanks to the mesh underarms
- COMFORT: the segmented bands provide flexibility
- ANTIFOULING: anti-dirt inserts including collar



UV



7SUNO



7SUNY



7SUNR

## TISSUS / FABRICS

- MAILLE BIRD-EYE : 100% Polyester - 140g/m<sup>2</sup> - UPF 50+
- MESH : 100% Polyester (aisselles)
- BANDES RÉTRO-RÉFLÉCHISSANTES : Bandes segmentées microbilles : 5cm
- BIRD-EYE KNIT: 100% Polyester - 140g/m<sup>2</sup> - UPF 50+
- MESH: 100% Polyester (armpit)
- RETRO-REFLECTIVE BANDS: segmented microbead bands: 5cm

## CARACTÉRISTIQUES / FEATURES

- Col en V
- Manches longues
- Empiècements contrastés : Col + Aisselles + Poignets + Bas
- Maille filet sous les aisselles
- Tissu anti-UV
- Bandes segmentées : 2 bretelles + 1 ceinture + 2 brassards/manche
- NB lavages : 30
- V-neck
- Long sleeves
- Contrasting yokes: Collar + Armpit + Cuffs + Bottom
- Mesh under arms
- UV protection on fabric
- Segmented bands: 2 straps + 1 belt + 2 armbands/sleeve
- NB washes: 30

TAILLES SIZES	S	M	L	XL	2XL	3XL
ORANGE HV / MARINE HV ORANGE / NAVY BLUE	7SUNOS	7SUNOM	7SUNOL	7SUNOXL	7SUNOXXL	7SUNOXXXL
JAUNE HV / MARINE HV YELLOW / NAVY BLUE	7SUNYS	7SUNYM	7SUNYL	7SUNYXL	7SUNYXXL	7SUNYXXXL
ROUGE HV / MARINE HV RED / NAVY BLUE	7SUNRS	7SUNRM	7SUNRL	7SUNRXL	7SUNRXXL	7SUNRXXXL
CONDITIONNEMENT PACKAGING	Emballage individuel ou par 20 / Individual pack or per 20					



EN 20471  
S



EN 20471  
M+



# RIKKA

5RIK170 / 5RIK160



## AVANTAGES / BENEFITS

- PROTECTION: tissu avec traitement anti-UV (UPF35+)
- CONFORT: Coton côté peau
- ANTISALISSURE: Empiècements contrastés
- PROTECTION: fabrics with anti-UV treatment (UPF35+)
- COMFORT: Cotton skin side
- ANTIPOULING: Contrasting inserts



5RIK160



5RIK170



## TISSUS / FABRICS

- MAILLE BIRD-EYE: 55% Coton / 45% Polyester - 150g/m<sup>2</sup> - UPF 35+
- BIRD-EYE KNIT: 55% Cotton / 45% Polyester - 150g/m<sup>2</sup> - UPF 35+
- BANDES RÉTRO-RÉFLÉCHISSANTES: Bandes cousues microbilles: 5cm
- RETRO-REFLECTIVE BANDS: sewn microbead bands: 5cm

## CARACTÉRISTIQUES / FEATURES

- Col rond
- Manches longues
- Empiècements contrastés: Col + Épaules + Côtés
- Tissu anti-UV
- Bandes cousues: 2 ceintures
- NB lavages : 50
- Round neck
- Long sleeves
- Contrasting yokes: Collar + Shoulders + Sides
- UV protection on fabric
- Sewn bands: 2 belts
- NB washes: 50



EN 20471  
S-M



EN 20471  
L+

TAILLES SIZES	S	M	L	XL	2XL	3XL
ORANGE HV / MARINE HV ORANGE / NAVY BLUE	5RIK17000S	5RIK17000M	5RIK17000L	5RIK1700XL	5RIK1702XL	5RIK1703XL
JAUNE HV / MARINE HV YELLOW / NAVY BLUE	5RIK16000S	5RIK16000M	5RIK16000L	5RIK1600XL	5RIK1602XL	5RIK1603XL
CONDITIONNEMENT PACKAGING	Emballage individuel ou par 20 / Individual pack or per 20					



# YARD

7YAPY\* / 7YAPO\*



## AVANTAGES / BENEFITS

- CONFORT: contient du coton
- ANTISSALISSURE: col polo en coloris contrasté
- COMFORT: contains cotton
- ANTIFOULING: polo neck in contrasting colors



7YAPO



7YAPY

## TISSUS / FABRICS

- MAILLE CÔTELÉE : 75% Polyester / 25% Coton - 180g/m<sup>2</sup>
- BORDS-CÔTES : 100% Coton (col)

- KNITTED RIBBED: 75% Polyester / 25% Cotton - 180g/m<sup>2</sup>
- RIB: 100% Cotton (collar)

- BANDES RÉTRO-RÉFLÉCHISSANTES : Bandes cousues microbilles : 5cm

- RETRO-REFLECTIVE BANDS: sewn microbead bands: 5cm

## CARACTÉRISTIQUES / FEATURES

- Col polo
- Manches longues
- Empiècement contrasté : Col
- Bandes cousues : 2 bretelles + 2 ceintures + 2 brassards/manche
- NB lavages : 25

- Polo collar
- Long sleeves
- Contrasting yoke: Collar
- Sewn bands: 2 straps + 2 belts + 2 armbands/sleeve
- NB washes: 25

TAILLES SIZES	M	L	XL	2XL	3XL
JAUNE HV / NOIR* HV YELLOW / BLACK*	7YAPYM	7YAPYL	7YAPYXL	7YAPYXXL	7YAPYXXXL
ORANGE HV / NOIR* HV ORANGE / BLACK*	7YAPOM	7YAPOL	7YAPOXL	7YAPOXXL	7YAPOXXXL
CONDITIONNEMENT PACKAGING	Emballage individuel ou par 20 / Individual pack or per 20				



EN 20471

\* Dans la limite des stocks disponibles / Within the limit of the available stock



# KOMO

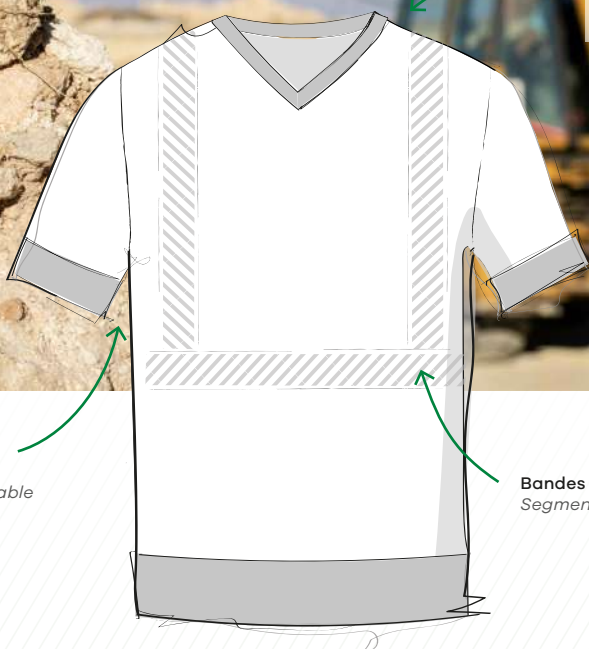

Col V  
V neckline

Mesh respirant  
sous les bras  
*Underarm breathable  
mesh*

Bandes segmentées  
*Segmented bands*



## MAILLE 2D = CONFORT 2D KNITTED MESH = COMFORT

Matière mixée coton/polyester.  
*Mixed cotton/polyester material.*

Polyester = face extérieure  
→ Séchage rapide et durabilité

*Polyester = outer side  
→ Quick drying and  
durability*

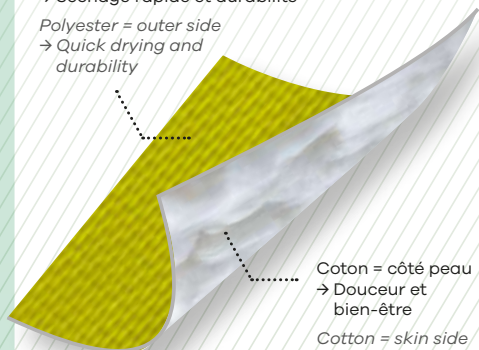

Coton = côté peau  
→ Douceur et  
bien-être

*Cotton = skin side  
→ Softness and  
well-being*



## FOCUS / FOCUS



### BANDES SEGMENTÉES = CONFORT

Les bandes thermocollées segmentées apportent souplesse, respirabilité et anti-irritations (sur la face peau)

### SEGMENTED BANDS = COMFORT

*Segmented thermofused bands provide flexibility, breathability and anti-irritation (on skin side)*



### MAILLE AJOURÉE = AÉRATION

La maille filet sous les aisselles favorise une respirabilité optimale grâce à la circulation d'un flux d'air

### MESH = VENTILATION

*The mesh underarm provides optimal breathability thanks to the circulation of an air flow circulation*





# KOMO

7KOMY / 7KOMO / 7KOMR



## AVANTAGES / BENEFITS

- RESPIRANT: bonne ventilation grâce aux aisselles en mesh
- CONFORT : coton côté la peau + bandes segmentées
- ANTISSALISSURE: empiècements contrastés dont au col
- BREATHABLE: good ventilation thanks to the mesh underarms
- COMFORT: skin side cotton + segmented bands
- ANTIFOULING: contrasted inserts on the collar



7KOMY



7KOMO



7KOMR

## TISSUS / FABRICS

- MAILLE BIRD-EYE : 55% Coton / 45% Polyester - 150g/m<sup>2</sup>
- BANDES RÉTRO-RÉFLÉCHISSANTES : Bandes segmentées microbilles : 5cm
- BIRD-EYE KNIT: 55% Cotton / 45% Polyester - 150g/m<sup>2</sup>
- RETRO-REFLECTIVE BANDS: segmented microbead bands: 5cm

## CARACTÉRISTIQUES / FEATURES

- Col en V
- Empiècements contrastés : Col + Aisselles + Bas de manches + Bas
- Bandes segmentées : 2 bretelles + 1 ceinture
- NB lavages : 25
- V-neck
- Contrasting yokes: Collar + Armpit + Sleeve ends + Bottom
- Segmented bands: 2 straps + 1 belt
- NB washes: 25

# KYRIO

7KYRY / 7KYRO



## AVANTAGES / BENEFITS

- PROTECTION: tissu avec un anti-UV (UPF 50+)
- RESPIRANT: bonne ventilation grâce aux aisselles en mesh
- CONFORT : les bandes segmentées apportent la souplesse
- ANTISSALISSURE: empiècements contrastés dont au col
- PROTECTION: fabric with anti-UV (UPF 50+)
- BREATHABLE: good ventilation thanks to the mesh underarms
- COMFORT: segmented bands provide flexibility
- ANTIFOULING: anti-dirt inserts including collar



7KYRY



7KYRO

## TISSUS / FABRICS

- MAILLE BIRD-EYE : 100% Polyester - 140g/m<sup>2</sup> - UPF 50+
- BANDES RÉTRO-RÉFLÉCHISSANTES : Bandes segmentées microbilles : 5cm
- BIRD-EYE KNIT: 100% Polyester - 140g/m<sup>2</sup> - UPF 50+
- RETRO-REFLECTIVE BANDS: segmented microbead bands: 5cm

## CARACTÉRISTIQUES / FEATURES

- Col en V
- Empiècements contrastés : Col + Aisselles + Bas de manches + Bas
- Bandes segmentées : 2 bretelles + 1 ceinture
- NB lavages : 30
- V-neck
- Contrasting yokes: Collar + Armpit + Sleeve ends + Bottom
- Segmented bands: 2 straps + 1 belt
- NB washes: 30

TAILLES SIZES		S	M	L	XL	2XL	3XL
KOMO	JAUNE HV / MARINE HV YELLOW / NAVY BLUE	7KOMYS	7KOMYM	7KOMYL	7KOMYXL	7KOMYXXL	7KOMYXXXL
	ORANGE HV / MARINE HV ORANGE / NAVY BLUE	7KOMOS	7KOMOM	7KOMOL	7KOMOXL	7KOMOXXL	7KOMOXXXL
	ROUGE HV / MARINE HV RED / NAVY BLUE	7KOMRS	7KOMRM	7KOMRL	7KOMRXL	7KOMRXXL	7KOMRXXXL
KYRIO	JAUNE HV / MARINE HV YELLOW / NAVY BLUE	7KYRYS	7KYRYM	7KYRYL	7KYRYXL	7KYRYXXL	7KYRYXXXL
	ORANGE HV / MARINE HV ORANGE / NAVY BLUE	7KYROS	7KYROM	7KYROL	7KYROXL	7KYROXXL	7KYROXXXL
	CONDITIONNEMENT PACKAGING		Emballage individuel ou par 20 / Individual pack or per 20				



EN 20471

# NEKKI

5NEK170 / 5NEK160



## AVANTAGES / BENEFITS

- PROTECTION: tissu avec traitement anti-UV (UPF35+)
- CONFORT: Coton côté peau
- ANTISALISSURE: Empiècements contrastés
- PROTECTION: fabrics with anti-UV treatment (UPF35+)
- COMFORT: Cotton skin side
- ANTIFOULING: Contrasting inserts



5NEK170



5NEK160

## TISSUS / FABRICS

- MAILLE BIRD-EYE : 55% Coton / 45% Polyester - 150g/m<sup>2</sup> - UPF 35+
- BANDES RÉTRO-RÉFLÉCHISSANTES: Bandes cousues microbilles: 6cm (S-L), 5cm (XL+)
- BIRD-EYE KNIT: 55% Cotton / 45% Polyester - 150g/m<sup>2</sup> - UPF 35+
- RETRO-REFLECTIVE BANDS: sewn microbead bands: 6cm (S-L), 5cm (XL+)

## CARACTÉRISTIQUES / FEATURES

- Col rond
- Manches courtes
- Empiècements contrastés: Col + Épaules + Côtés
- Tissu anti-UV
- Bandes cousues: 2 ceintures
- NB lavages : 50
- Round neck
- Short sleeves
- Contrasting yokes: Collar + Shoulders + Sides
- UV protection on fabric
- Sewn bands: 2 belts
- NB washes: 50

TAILLES SIZES	S	M	L	XL	2XL	3XL
ORANGE HV / MARINE HV ORANGE / NAVY BLUE	5NEK17000S	5NEK17000M	5NEK17000L	5NEK1700XL	5NEK1702XL	5NEK1703XL
JAUNE HV / MARINE HV YELLOW / NAVY BLUE	5NEK16000S	5NEK16000M	5NEK16000L	5NEK1600XL	5NEK1602XL	5NEK1603XL
CONDITIONNEMENT PACKAGING	Emballage individuel ou par 20 / Individual pack or per 20					



EN 20471  
S-M



EN 20471  
L+



# T-SHIRT MANCHES COURTES / SHORT SLEEVES T-SHIRT

TEMPS CHAUD / WARM WEATHER

## YARD

7YATY\* / 7YATO\*



### AVANTAGES / BENEFITS

- CONFORT: contient du coton
- ANTISSALISSURE: col en coloris contrasté
- COMFORT: contains cotton
- ANTIFOULING: collar in contrasting colors



7YATY



7YATO

## YARD

7YAVY / 7YAVO



### AVANTAGES / BENEFITS

- LÉGER: matière en 140g/m<sup>2</sup>
- ANTISSALISSURE: col en coloris contrasté
- SÉCHAGE RAPIDE: en polyester
- LIGHT: 140g/m<sup>2</sup> material
- ANTIFOULING: collar in contrasting color
- FAST DRYING: in polyester



7YAVY



7YAVO

### TISSUS / FABRICS

- MAILLE COTELÉE : 75% Polyester / 25% Coton - 180g/m<sup>2</sup>
- BANDES RÉTRO-RÉFLÉCHISSANTES : Bandes segmentées microbilles : 5cm
- KNITTED RIBBED: 75% Polyester / 25% Cotton - 180g/m<sup>2</sup>
- RETRO-REFLECTIVE BANDS: sewn microbead bands: 5cm

### CARACTÉRISTIQUES / FEATURES

- Col rond
- Empiècements contrastés : Col + Bas de manches
- Manches courtes
- Bandes cousues : 2 bretelles + 2 ceintures
- NB lavages : 25
- Round neck
- Contrasting yokes: Collar + Sleeve ends
- Short sleeves
- Sewn bands: 2 straps + 2 belts
- NB washes: 25

### TISSUS / FABRICS

- MAILLE BIRD-EYE : 100% Polyester - 140g/m<sup>2</sup>
- BANDES RÉTRO-RÉFLÉCHISSANTES : Bandes cousues microbilles : 5cm
- BIRD-EYE KNIT: 100% Polyester - 140g/m<sup>2</sup>
- RETRO-REFLECTIVE BANDS: sewn microbead bands: 5cm

### CARACTÉRISTIQUES / FEATURES

- Col en V
- Empiècements contrastés : Col + Bas de manches
- Bandes cousues : 2 bretelles + 2 ceintures
- NB lavages : 25
- V-neck
- Contrasting yokes: Collar + Sleeve ends
- Sewn bands: 2 straps + 2 belts
- NB washes: 25

TAILLES SIZES	M	L	XL	2XL	3XL
JAUNE HV / MARINE* HV YELLOW / NAVY BLUE*	7YATYM	7YATYL	7YATYXL	7YATYXXL	7YATYXXXL
ORANGE HV / MARINE* HV ORANGE / NAVY BLUE*	7YATOM	7YATOL	7YATOXL	7YATOXXL	-
JAUNE HV / MARINE HV YELLOW / NAVY BLUE	7YAVYM	7YAVYL	7YAVYXL	7YAVYXXL	7YAVYXXXL
ORANGE HV / MARINE HV ORANGE / NAVY BLUE	7YAVOM	7YAVOL	7YAVOXL	7YAVOXXL	-
CONDITIONNEMENT PACKAGING	Emballage individuel ou par 20 / Individual pack or per 20				



EN 20471

\* Dans la limite des stocks disponibles / Within the limit of the available stock

# OKI

5OKI160 / 5OKI170



## AVANTAGES / BENEFITS

- PROTECTION: tissu avec traitement anti-UV (UPF35+)
- CONFORT: Coton côté peau
- ANTISSALISSURE: Empiècements contrastés
- PROTECTION: fabrics with anti-UV treatment (UPF35+)
- COMFORT: Cotton skin side
- ANTIFOULING: Contrasting inserts



5OKI160



5OKI170

# YARD

MO70270 / MO70280



## AVANTAGES / BENEFITS

- LÉGER: matière en 140g/m<sup>2</sup>
- ANTISSALISSURE: col polo en coloris contrasté
- SÉCHAGE RAPIDE: en polyester
- LIGHT: 140g/m<sup>2</sup> material
- ANTIFOULING: polo collar in contrasting colors
- FAST DRYING: in polyester



MO70270



MO70280

## TISSUS / FABRICS

- MAILLE BIRD-EYE: 55% Coton / 45% Polyester - 150g/m<sup>2</sup> - UPF 35+
- BANDES RÉTRO-RÉFLÉCHISSANTES: Bandes cousues microbilles: 6cm (S-L), 5cm (XL+)
- BIRD-EYE KNIT: 55% Cotton / 45% Polyester - 150g/m<sup>2</sup> - UPF 35+
- RETRO-REFLECTIVE BANDS: sewn microbead bands: 6cm (S-L), 5cm (XL+)

## CARACTÉRISTIQUES / FEATURES

- Col polo
- Manches courtes
- Tissu anti-UV
- Empiècements contrastés: Col + Épaules + Côtés
- Bandes cousues: 2 ceintures
- NB lavages : 50
- Polo collar
- Short sleeves
- UV protection on fabric
- Contrasting yokes: Collar + Shoulders + Sides
- Sewn bands: 2 belts
- NB washes: 50

## TISSUS / FABRICS

- MAILLE BIRD-EYE : 100% Polyester - 140g/m<sup>2</sup>
- BANDES RÉTRO-RÉFLÉCHISSANTES : Bandes cousues microbilles : 5cm
- BIRD-EYE KNIT: 100% Polyester - 140g/m<sup>2</sup>
- RETRO-REFLECTIVE BANDS: sewn microbead bands: 5cm

## CARACTÉRISTIQUES / FEATURES

- Col polo
- Manches courtes
- Empiècements contrastés : Col + Bas de manches
- Bandes cousues : 2 bretelles + 2 ceintures
- Polo collar
- Short sleeves
- Contrasting yokes: Collar + Sleeve ends
- Sewn bands: 2 straps + 2 belts

TAILLES / SIZES		S	M	L	XL	2XL	3XL
OKI	JAUNE HV / MARINE HV YELLOW / NAVY BLUE	5OKI16000S	5OKI16000M	5OKI16000L	5OKI1600XL	5OKI1602XL	5OKI1603XL
	ORANGE HV / MARINE HV ORANGE / NAVY BLUE	5OKI17000S	5OKI17000M	5OKI17000L	5OKI1700XL	5OKI1702XL	5OKI1703XL
YARD	JAUNE HV / MARINE HV YELLOW / NAVY BLUE	-	70270	70271	70272	70273	70274
	ORANGE HV / MARINE HV ORANGE / NAVY BLUE	-	70280	70281	70282	70283	-
CONDITIONNEMENT / PACKAGING		Emballage individuel ou par 20 / Individual pack or per 20					



EN 20471



GILET / VEST

# YARD

MO70216 / MO70236



## AVANTAGES / BENEFITS

- **VISIBLE:** baudrier
- **EMBALLAGE:** Version brochable ou éco
- **VISIBLE:** harness
- **PACKAGING:** hangable or eco version



MO70206  
MO70216



MO70226  
MO70236

## TISSUS / FABRICS

- 100% Polyester - 120g/m<sup>2</sup>
- **BANDES RÉTRO-RÉFLÉCHISSANTES :** Bandes cousues microbilles : 5cm
- 100% Polyester - 120g/m<sup>2</sup>
- **RETRO-REFLECTIVE BANDS:** sewn microbead bands: 5cm

## CARACTÉRISTIQUES / FEATURES

- Fermeture par scratchs
- Bandes cousues : 2 bretelles + 1 ceinture
- NB lavages : 25
- *Closing by velcro*
- *Sewn bands : 2 straps + 1 belt*
- *NB washes: 25*



EN 20471

MODÈLES MODELS	COULEURS COLORS	TAILLES SIZES	EMBALLAGE PACK
MO70216	Jaune HV HV Yellow	XL	BROCHABLE HANGABLE
MO70236	Orange HV HV Orange	XL	
MO70206	Jaune HV HV Yellow	XL	SACHET ECO ECO POLYBAG
MO70226	Orange HV HV Orange	XL	
<b>CONDITIONNEMENT PACKAGING</b>	Emballage individuel brochable ou par 50 / Hangable individual pack or per 50		

# YARD

MO70212 / MO70232



## AVANTAGES / BENEFITS

- **VISIBLE:** double bande ceinture
- **EMBALLAGE:** Version brochable ou éco
- **DIFFÉRENTS TAILLANTS:** 2 tailles
- **VISIBLE:** double belt
- **PACKAGING:** hangable or eco version
- **DIFFERENT SIZES:** 2 sizes



MO70212



MO70232

## TISSUS / FABRICS

- 100% Polyester - 120g/m<sup>2</sup>
- **BANDES RÉTRO-RÉFLÉCHISSANTES :** Bandes cousues microbilles : 5cm
- 100% Polyester - 120g/m<sup>2</sup>
- **RETRO-REFLECTIVE BANDS:** sewn microbead bands: 5cm

## CARACTÉRISTIQUES / FEATURES

- Fermeture par scratchs
- Bandes cousues : 2 ceintures
- NB lavages : 25
- *Closing by velcro*
- *Sewn bands: 2 belts*
- *NB washes: 25*



EN 20471

MODÈLES MODELS	COULEURS COLORS	TAILLES SIZES	EMBALLAGE PACK
MO70212	Jaune HV HV Yellow	XL	BROCHABLE HANGABLE
MO70213		XXL	
MO70232	Orange HV HV Orange	XL	BROCHABLE HANGABLE
MO70233		XXL	
<b>CONDITIONNEMENT PACKAGING</b>	Emballage individuel brochable ou par 50 / Hangable individual pack or per 50		



# NEPPA

5NEP16 / 5NEP17



## AVANTAGES / BENEFITS

- PLUSIEURS TAILLES: 3 tailles
- AJUSTABLE: réglable en largeur
- SEVERAL SIZES: 3 sizes
- ADJUSTABLE: adjustable in width



5NEP16



5NEP17

## TISSUS / FABRICS

- 100% Polyester - 120g/m<sup>2</sup>
- BANDES RÉTRO-RÉFLÉCHISSANTES : Bandes cousues microbilles : 6cm (S/M), 5cm (L/XL, 2XL/3XL)
- 100% polyester - 120g/m<sup>2</sup>
- RETRO-REFLECTIVE BANDS: sewn microbead bands: 6cm (S/M), 5cm (L/XL, 2XL/3XL)

## CARACTÉRISTIQUES / FEATURES

- Fermeture par scratchs ajustables
- Bandes cousues : 2 ceintures
- NB lavages : 25
- Closing by adjustable velcro
- Sewn bands: 2 belts
- NB washes: 25



EN 20471

MODÈLES MODELS	COULEURS COLORS	TAILLES SIZES	EMBALLAGE PACK
5NEP160001	Jaune HV HV Yellow	S/M	SACHET ECO ECO POLYBAG
5NEP160002		L/XL	
5NEP160003		2XL/3XL	
5NEP170001	Orange HV HV Orange	S/M	
5NEP170002		L/XL	
5NEP170003		2XL/3XL	
CONDITIONNEMENT PACKAGING	Emballage individuel brochable ou par 50 / Hangable individual pack or per 50		

# YARD

MO70242 / MO70252 / MO70262 / MO70265\*



## AVANTAGES / BENEFITS

- VISIBLE: bandes bretelles pour être vu à 360°C
- BROCHABLE: emballage pouvant être mis sur broche
- PROFONDEUR DE GAMME: 4 couleurs
- VISIBLE: straps to be seen at 360°C
- HANGABLE: pin-on packaging
- RANGE DEPTH: 4 colors



MO70242



MO70252



MO70262



MO70265

## TISSUS / FABRICS

- 100% Polyester - 120g/m<sup>2</sup>
- BANDES RÉTRO-RÉFLÉCHISSANTES : Bandes cousues microbilles : 5cm
- 100% Polyester - 120g/m<sup>2</sup>
- RETRO-REFLECTIVE BANDS: sewn microbead bands: 5cm

## CARACTÉRISTIQUES / FEATURES

- Fermeture par scratchs
- Bandes cousues : 2 bretelles + 2 ceintures
- NB lavages : 25
- Closing by velcro
- Sewn bands: 2 straps + 2 belts
- NB washes: 25



EN 1150  
Vert / Green



EN 20471

MODÈLES MODELS	COULEURS COLORS	TAILLES SIZES	EMBALLAGE PACK
70242	Jaune HV HV Yellow	XL	BROCHABLE HANGABLE
70243		XXL	
70252	Orange HV HV Orange	XL	
70262	Vert HV HV Green	XL	
70265*	Rouge HV HV red	XL	
CONDITIONNEMENT PACKAGING	Emballage individuel brochable ou par 50 / Hangable individual pack or per 50		

\* Dans la limite des stocks disponibles / Within the limit of the available stock



GILET / VEST

# YARD

7YGMY / 7YGMO



## AVANTAGES / BENEFITS

- **VISIBLE:** bandes bretelles pour être vu à 360°C
- **BROCHABLE:** emballage pouvant être mis sur broche
- **ZIPPÉE:** fermeture centrale à glissière
- **VISIBLE:** straps to be seen at 360°C
- **HANGABLE:** packaging can be put on a spindle
- **ZIPPED:** central zipper



7YGMY



7YGMO

## TISSUS / FABRICS

- 100% Polyester - 120g/m<sup>2</sup>
- **BANDES RÉTRO-RÉFLÉCHISSANTES :** Bandes cousues microbilles : 5cm
- 100% polyester - 120g/m<sup>2</sup>
- **RETRO-REFLECTIVE BANDS:** sewn microbead bands: 5cm

## CARACTÉRISTIQUES / FEATURES

- Fermeture par zip central
- Bandes cousues : 2 bretelles + 2 ceintures
- 2 poches basses à soufflet + rabat fermé par scratch
- 2 poches repose-mains
- 1 poche téléphone
- 1 poche stylo
- NB lavages : 25

- Closing by central zipper
- Sewn bands: 2 straps + 2 belts
- 2 lower pockets + flap closed by velcro
- 2 hand rest pockets
- 1 phone pocket
- 1 pen pocket
- NB washes: 25



EN 20471

MODÈLES MODELS	COULEURS COLORS	TAILLES SIZES	EMBALLAGE PACK
7YGMXXL	Jaune HV HV Yellow	S/M	BROCHABLE HANGABLE
7YGMYYXL		L/XL	
7YGMOXL	Orange HV HV Orange	S/M	
7YGMOXXL		L/XL	
<b>CONDITIONNEMENT PACKAGING</b>	Emballage individuel brochable ou par 50 / Hangable individual pack or per 50		

# YARD

7CHIL



## AVANTAGES / BENEFITS

- **VISIBLE:** bandes bretelles pour être vu à 360°C
- **BROCHABLE:** emballage pouvant être mis sur broche
- **VISIBLE:** straps to be seen at 360°C
- **HANGABLE:** packaging that can be put on a spindle



7KIDY / 7JUNY

## TISSUS / FABRICS

- 100% Polyester - 120g/m<sup>2</sup>
- **BANDES RÉTRO-RÉFLÉCHISSANTES :** Bandes cousues microbilles : 5cm
- 100% polyester - 120g/m<sup>2</sup>
- **RETRO-REFLECTIVE BANDS:** sewn microbead bands: 5cm

## CARACTÉRISTIQUES / FEATURES

- Fermeture par scratchs
- Bandes cousues : 2 bretelles + 2 ceintures
- NB lavages : 25

- Closing by velcro
- Sewn bands: 2 straps + 2 belts
- NB washes: 25



EN 1150

MODÈLES MODELS	COULEURS COLORS	TAILLES SIZES	EMBALLAGE PACK
7KIDY	Jaune HV HV Yellow	8-10 ans	BROCHABLE HANGABLE
7JUNY		8-10 years	
		12-14 ans 12-14 years	
<b>CONDITIONNEMENT PACKAGING</b>	Emballage individuel brochable ou par 50 / Hangable individual pack or per 50		



# VÊTEMENTS DE TRAVAIL

**WORKWEAR**

VESTE / JACKET

# PATROL

7PAJV\* / 7PAOV\*



**AVANTAGES / BENEFITS**

- CONFORT: majoritaire coton
- PROTECTION: dos rallongé
- ANTISALISSURE: zones en coloris contrasté
- COMFORT: majority cotton
- PROTECTION: longer back
- ANTIFOULING: zones in contrasting colors

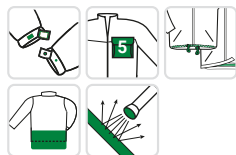

7PAJV



7PAOV

**TISSUS / FABRICS**

- SERGÉ HV: 60% Coton / 40% Polyester - 245g/m<sup>2</sup>
- SERGÉ MARINE: 65% Polyester / 35% Coton - 245g/m<sup>2</sup>
- TWILL HV: 60% Coton / 40% Polyester - 245g/m<sup>2</sup>
- TWILL NAVY: 65% Polyester / 35% Coton - 245g/m<sup>2</sup>
- BANDES RÉTRO-RÉFLÉCHISSANTES : Bandes cousues microbilles : 5cm
- RETRO-REFLECTIVE BANDS: sewn microbead bands: 5cm

**CARACTÉRISTIQUES / FEATURES**

- Col montant
- Vignette d'identification
- Zip central
- Poignets ajustables par scratch
- Pattes de réglage côtés à scratch
- 1 poche poitrine zippée + « garage »
- 2 poches basses repose mains à scratch
- 2 poches basses intérieures
- Protège reins
- Bandes cousues : 2 épaules + 2 ceintures + 2 brassards/manche
- High collar
- Identification sticker
- Central zip
- Cuff adjustable by velcro
- Adjustment tabs with velcro sides
- 1 zipped chest pocket + «garage»
- 2 lower hand pockets
- 2 lower inside pockets
- Extended back
- Sewn bands: 2 shoulders + 2 belts + 2 armbands/sleeve

TAILLES SIZES	S	M	L	XL	2XL	3XL
JAUNE HV / MARINE* HV YELLOW / NAVY BLUE*	7PAJVS	7PAJVM	7PAJVL	7PAJVXL	7PAJVXXL	7PAJVXXXL
ORANGE HV / MARINE* HV ORANGE / NAVY BLUE*	7PAOVS	7PAOVM	7PAOVL	7PAOVXL	7PAOVXXL	7PAOVXXXL
CONDITIONNEMENT PACKAGING	Emballage individuel brochable ou par 10 / Hangable individual pack or per 10					



EN 20471

\* Dans la limite des stocks disponibles / Within the limit of the available stock

# PATROL

7PAJP / 7PAOP



## AVANTAGES / BENEFITS

- CONFORT: majoritaire coton
- PROTECTION: mercerie apparente en plastique (amagnétique anti-rayures)
- ANTISALISSURE: zones en coloris contrasté
- COMFORT: majority cotton
- PROTECTION: visible plastic haberdashery (non-magnetic anti-scratch)
- ANTIFOULING: zones in contrasting colors



7PAJP



7PAOP

## TISSUS / FABRICS

- SERGÉ HV: 60% Coton / 40% Polyester - 245g/m<sup>2</sup>
- SERGÉ MARINE: 65% Polyester / 35% Coton - 245g/m<sup>2</sup>
- TWILL HV: 60% Cotton / 40% Polyester - 245g/m<sup>2</sup>
- TWILL NAVY: 65% Polyester / 35% Cotton - 245g/m<sup>2</sup>
- BANDES RÉTRO-RÉFLÉCHISSANTES : Bandes cousues microbilles : 7cm
- RETRO-REFLECTIVE BANDS: sewn microbead bands: 7cm

## CARACTÉRISTIQUES / FEATURES

- Ceinture élastiquée côtés + Passants
- 2 poches italiennes
- 2 poches cargos
- 2 poches dos à rabat
- Contrastes de couleur: genoux, fesses, chevilles
- Bandes cousues : 2 brassards/jambe
- Elasticated waistband on sides + Loops
- 2 italian pockets
- 2 back pockets with flap
- 2 cargo pockets
- Contrasted colour: knees, buttocks, ankles
- Sewn bands: 2 armbands/leg

TAILLES SIZES	XS	S	M	L	XL	2XL	3XL
JAUNE HV / MARINE HV YELLOW / NAVY BLUE	7PAJPXS	7PAJPS	7PAJPM	7PAJPL	7PAJPXL	7PAJPXXL	7PAJPXXXL
ORANGE HV / MARINE HV ORANGE / NAVY BLUE	-	7PAOPS	7PAOPM	7PAOPL	7PAOPXL	7PAOPXXL	7PAOPXXXL
CONDITIONNEMENT PACKAGING	Emballage individuel ou par 10 / Individual pack or per 10						



EN 20471





# HIBANA



Réhausse dos  
Raised back



**STRETCH**

Entrejambe stretch  
Stretch crotch

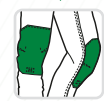
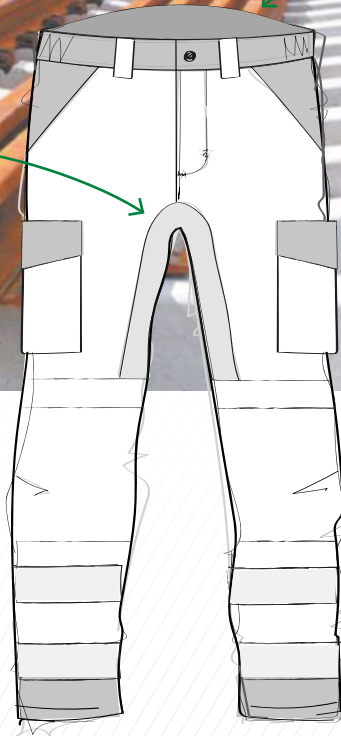

Poches genoux en Oxford  
Oxford kneepad pockets

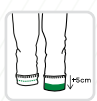

Ourlet supplémentaire  
intégré  
Adjustable leg length



**STRETCH = CONFORT**  
**STRETCH = COMFORT**

**← STRETCH →**

Les nombreux empiècements stretch (arrière du genou, entrejambe, réhausse dos) permettent de libérer les points de tension du produit

→ Favorise l'aisance dans les mouvements du travailleur

→ Limite les douleurs du porteur

*The several stretch inserts (back of the knee, crotch, back raise) release the product's stress points*

→ Allows the worker to move with ease

→ Limits the wearer's pain



## FOCUS / FOCUS



**OXFORD ENDUIT = DÉPERLANCE & RÉSISTANCE**  
Structure de tissage solide + traitement de surface permettant à l'eau de ruisseler.  
→ Idéal pour des zones de renforts

**COATED OXFORD = WATER-REPELLENCE & RESISTANCE**  
Strong weave structure + surface treatment allowing water to run off  
→ Ideal for reinforcement zones



**CEINTURE ERGONOMIQUE = SOUPLESSE**  
Sa réhausse dos, ses élastiques côtés et sa zone de stretch en fond un atout pour protéger les lombaires du travailleur, limiter les courants d'air et s'adapter à toutes les morphologies

**ERGONOMIC BELT = FLEXIBILITY**  
Its back extension, side elastics and stretch zone make it an excellent asset for protecting the worker's lumbar region, limiting draughts and adapting to all morphologies



VESTE / JACKET

# HIBANA

5HBJ170 / 5HBJ160 / 5HBJ130



**AVANTAGES / BENEFITS**

- CONFORT: zones de tension élastiquées
- PROTECTION: dos rallongé
- ANTISALISSURE: zones en coloris contrasté
- COMFORT: *elasticated tension zones*
- PROTECTION: *extended back*
- ANTIFOULING: *zones in contrasting colors*



5HBJ170



5HBJ160



5HBJ130

**TISSUS / FABRICS**

- SERGÉ: 60% Coton / 40% Polyester - 270g/m<sup>2</sup>
- STRETCH: 90% Polyamide / 10% Élasthanne - 270g/m<sup>2</sup>
- BANDES RÉTRO-RÉFLÉCHISSANTES: Bandes cousues microbilles: 5cm

- TWILL: 60% Cotton / 40% Polyester - 270g/m<sup>2</sup>
- STRETCH: 90% Polyamide / 10% Elastane - 270g/m<sup>2</sup>
- RETRO-REFLECTIVE BANDS: sewn microbead bands: 5cm

**CARACTÉRISTIQUES / FEATURES**

- Col montant
- Zip central sous rabat à scratchs
- Emmanchures dos en stretch
- Poignets ajustables par scratch
- Pattes de réglage côtés à scratch
- 2 poches poitrine à soufflet + rabat fermé par scratch
- 2 poches basses sous passepoil
- Empiècements contrastés: Épaules + Côtés + Avant-bras
- Dos rallongé
- Bandes cousues: 2 épaules + 2 ceintures + 2 brassards/manche
- NB lavages : 25

- High collar
- Central zip under flap with velcro
- Back armholes in stretch
- Cuff adjustable by velcro
- Adjustment tabs with velcro sides
- 2 chest pockets with gusset + flap closed by velcro
- 2 lower pockets under piping
- Contrasting yokes: Shoulders + Sides + Forearms
- Extended back
- Sewn bands: 2 shoulders + 2 belts + 2 armbands/sleeve
- NB washes: 25

TAILLES SIZES	S	M	L	XL	2XL	3XL	4XL
ORANGE HV / MARINE HV ORANGE / NAVY BLUE	5HBJ17000S	5HBJ17000M	5HBJ17000L	5HBJ1700XL	5HBJ1702XL	5HBJ1703XL	5HBJ1704XL
JAUNE HV / MARINE HV YELLOW / NAVY BLUE	5HBJ16000S	5HBJ16000M	5HBJ16000L	5HBJ1600XL	5HBJ1602XL	5HBJ1603XL	5HBJ1604XL
ROUGE HV / MARINE HV RED / NAVY BLUE	5HBJ13000S	5HBJ13000M	5HBJ13000L	5HBJ1300XL	5HBJ1302XL	5HBJ1303XL	5HBJ1304XL
CONDITIONNEMENT PACKAGING	Emballage individuel brochable ou par 10 / Hangable individual pack or per 10						



EN 20471  
S-L



EN 20471  
XL+



# HIBANA

5HBA17 / 5HBA16 / 5HBA130



## AVANTAGES / BENEFITS

- CONFORT: zones de tension élastiquées
- PROTECTION: réhausse dos + poches genoux en Oxford
- FONCTIONNEL: extra ourlet intégré
- ANTISALISSURE: zones en coloris contrasté
- COMFORT: elasticated tension zones
- PROTECTION: back cover + knee pockets in Oxford
- FUNCTIONAL: extra integrated hem
- ANTIFOULING: zones in contrasting colors



5HBA17



5HBA16



5HBA130



8KNEE

## TISSUS / FABRICS

- SERGÉ : 60% Coton / 40% Polyester - 270g/m<sup>2</sup>
- STRETCH : 90% Polyamide / 10% Élasthanne - 270g/m<sup>2</sup>
- OXFORD : 100% Polyester - 300D
- TWILL : 60% Cotton / 40% Polyester - 270g/m<sup>2</sup>
- STRETCH: 90% Polyamide / 10% Elastane - 270g/m<sup>2</sup>
- OXFORD: 100% Polyester - 300D
- BANDES RÉTRO-RÉFLÉCHISSANTES: Bandes cousues microbilles: 7cm
- RETRO-REFLECTIVE BANDS: sewn microbead bands: 7cm

## CARACTÉRISTIQUES / FEATURES

- Ceinture élastiquée côtés + Passants
- Réhausse dos avec empècement stretch
- 2 poches italiennes
- 2 poches dos fermées par rabat à scratch
- 2 poches cargo fermées par scratch
- Panneau d'aisance entrejambe stretch
- Arrière des genoux en stretch
- Poches genoux en Oxford, ouverture par le haut
- Triple surpiqure
- Ourlet supplémentaire: +5cm
- Coupe regular
- Bandes cousues: 2 brassards/jambe
- NB lavages : 25
- Elasticated waistband on the sides + Loops
- Raised back with stretch yoke
- 2 Italian pockets
- 2 back pockets with flaps
- 2 cargo pockets closed by velcro
- Stretch crotch gusset panel
- Back of knees in stretch
- Oxford kneepad pockets, top loading
- Triple topstitching
- Adjustable leg length: +5cm
- Regular cut
- Swen bands: 2 armbands/leg
- NB washes: 25

TAILLES SIZES	S	M	L	XL	2XL	3XL	4XL
ORANGE HV / MARINE HV ORANGE / NAVY BLUE	5HBA17000S	5HBA17000M	5HBA17000L	5HBA1700XL	5HBA1702XL	5HBA1703XL	5HBA1704XL
JAUNE HV / MARINE HV YELLOW / NAVY BLUE	5HBA16000S	5HBA16000M	5HBA16000L	5HBA1600XL	5HBA1602XL	5HBA1603XL	5HBA1604XL
ROUGE HV / MARINE HV RED / NAVY BLUE	5HBA13000S	5HBA13000M	5HBA13000L	5HBA1300XL	5HBA1302XL	5HBA1303XL	5HBA1304XL
CONDITIONNEMENT PACKAGING	Emballage individuel brochable ou par 10 / Hangable individual pack or per 10						



EN 20471  
S+M



EN 20471  
L+



EN 14404  
TYPE 2

COTTE / BIB-PANT

# HIBANA

5HBB170 / 5HBB160



## AVANTAGES / BENEFITS

- CONFORT: zones de tension élastiquées + bretelles élastiquées
- PROTECTION: poches genoux en Oxford
- FONCTIONNELLE: extra ourlet intégré
- ANTISALISSURE: zones en coloris contrasté
- COMFORT: *elasticated tension zones + elasticated shoulder straps*
- PROTECTION: *Oxford knee pockets*
- FUNCTIONAL: *extra integrated hem*
- ANTIFOULING: *zones in contrasting colors*

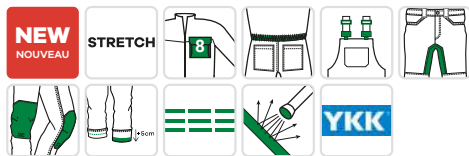

5HBB170



5HBB160



8KNEE

## TISSUS / FABRICS

- SERGÉ : 60% Coton / 40% Polyester - 270g/m<sup>2</sup>
- STRETCH : 90% Polyamide / 10% Élasthanne - 270g/m<sup>2</sup>
- OXFORD: 100% Polyester - 300D
- BANDES RÉTRO-RÉFLÉCHISSANTES: Bandes cousues microbilles: 7cm

- TWILL: 60% Cotton / 40% Polyester - 270g/m<sup>2</sup>
- STRETCH: 90% Polyamide / 10% Elastane - 270g/m<sup>2</sup>
- OXFORD: 100% Polyester - 300D
- RETRO-REFLECTIVE BANDS: sewn microbead bands: 7cm

## CARACTÉRISTIQUES / FEATURES

- Bretelles ajustables élastiquées dos + Boucles plastiques
- Fermeture côtés par 4 boutons clou + calotte plastique
- Ceinture élastiquée dos + Passants
- Réhausse dos avec empèchement stretch
- 1 poche bavette zippée
- 1 poche bavette à soufflet à rabat
- 2 poches italiennes
- 2 poches dos fermées par rabat à scratch
- 2 poches cargo fermées par scratch
- Panneau d'aisance entrejambe stretch
- Arrière des genoux en stretch
- Poches genoux en Oxford, ouverture par le haut
- Triple surpiqûre
- Ourlet supplémentaire: +5cm
- Coupe regular
- Bandes cousues: 2 brassards/jambe
- NB lavages : 25
- Adjustable elasticated back braces + Plastic buckles
- Side fastening by 4 tack buttons with plastic cap
- Elasticated back belt + Loops
- Raised back with stretch yoke
- 1 zipped bib pocket
- 1 gusseted bib pocket with flap
- 2 Italian pockets
- 2 back pockets with flaps
- 2 cargo pockets closed by velcro
- Stretch crotch gusset panel
- Back of knees in stretch
- Oxford kneepad pockets, top loading
- Triple topstitching
- Adjustable leg length: +5cm
- Regular cut
- Swen bands: 2 armbands/leg
- NB washes: 25



EN 20471  
S+M



EN 20471  
L+



EN 14404  
TYPE 2

TAILLES SIZES	S	M	L	XL	2XL	3XL	4XL
ORANGE HV / MARINE HV ORANGE / NAVY BLUE	5HBB17000S	5HBB17000M	5HBB17000L	5HBB1700XL	5HBB1702XL	5HBB1703XL	5HBB1704XL
JAUNE HV / MARINE HV YELLOW / NAVY BLUE	5HBB16000S	5HBB16000M	5HBB16000L	5HBB1600XL	5HBB1602XL	5HBB1603XL	5HBB1604XL
CONDITIONNEMENT PACKAGING	Emballage individuel brochable ou par 5 / Hangable individual pack or per 5						

# HIBANA

5HBS170 / 5HBS160



## AVANTAGES / BENEFITS

- CONFORT: zones de tension élastiquées
- PROTECTION: réhausse dos
- ANTISALISSURE: zones en coloris contrasté
- COMFORT: elasticated tension zones
- PROTECTION: back padding
- ANTIFOULING: zones in contrasting colors

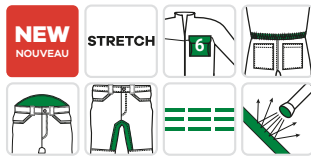

5HBS170



5HBS160

## TISSUS / FABRICS

- SERGÉ: 60% Coton / 40% Polyester - 270g/m<sup>2</sup>
- STRETCH: 90% Polyamide / 10% Élasthanne - 270g/m<sup>2</sup>
- OXFORD: 100% Polyester - 300D

- TWILL: 60% Coton / 40% Polyester - 270g/m<sup>2</sup>
- STRETCH: 90% Polyamide / 10% Elastane - 270g/m<sup>2</sup>
- OXFORD: 100% Polyester - 300D

- BANDES RÉTRO-RÉFLÉCHISSANTES: Bandes cousues microbilles: 5cm

- RETRO-REFLECTIVE BANDS: sewn microbead bands: 5cm

## CARACTÉRISTIQUES / FEATURES

- Ceinture élastiquée côtés + Passants
- Réhausse dos avec empîement stretch
- 2 poches italiennes
- 2 poches dos fermées par rabat à scratch
- 2 poches cargo fermées par scratch
- Panneau d'aisance entrejambe stretch
- Triple surpiqûre
- Coupe regular
- Bandes cousues: 2 brassards/jambe
- Longueur genou
- NB lavages : 25

- Elasticated waistband on the sides + Loops
- Raised back with stretch yoke
- 2 Italian pockets
- 2 back pockets with flaps
- 2 cargo pockets closed by velcro
- Stretch crotch gusset panel
- Triple topstitching
- Regular cut
- Swen bands: 2 armbands/leg
- Knee length
- NB washes: 25

TAILLES SIZES	S	M	L	XL	2XL	3XL	4XL
ORANGE HV / MARINE HV ORANGE / NAVY BLUE	5HBS17000S	5HBS17000M	5HBS17000L	5HBS1700XL	5HBS1702XL	5HBS1703XL	5HBS1704XL
JAUNE HV / MARINE HV YELLOW / NAVY BLUE	5HBS16000S	5HBS16000M	5HBS16000L	5HBS1600XL	5HBS1602XL	5HBS1603XL	5HBS1604XL
CONDITIONNEMENT PACKAGING	Emballage individuel brochable ou par 10 / Hangable individual pack or per 10						



EN 20471



# LES COMBINABLES / THE COMBOS

## → LE CONCEPT / THE CONCEPT

Un concept **polyvalent** offrant une multitude de choix de combinaisons. Il a été pensé pour s'adapter aux conditions saisonnières de l'automne au printemps en offrant une **protection complète pour tous les temps**

A **multi-purpose** concept offering a multitude of combination options. It has been designed to adapt to seasonal conditions from autumn to spring, offering **complete protection for all weathers**

Zip compatible entre /  
Zip compatible between

- 1 la coque / shell
- 2 la doublure / lining



### 1 JE CHOISIS MA PARKA I CHOOSE MY PARKA

**Parka extérieure** doublée en coton FR et aux coutures étanchées pour lutter contre la pluie.

*Outer parka with FR cotton lining and taped seams to fight against the rain*

### 2 JE CHOISIS MA DOUBLURE I CHOOSE MY LINING

**Veste polaire** pour apporter chaleur et confort

*Fleece jacket to bring warmth and comfort*



ou / or



**NOTT 5NOT16**  
Parka de pluie HV FR  
HV FR Rain parka

**DAGDA 5DAG120**  
Parka de pluie FR  
FR Rain parka

**PIKKER 5PIK120**  
Veste polaire FR  
IFR fleece jacket

### 3 J'OBTIENS UNE MULTITUDE DE POSSIBILITÉS I GET A MULTITUDE OF POSSIBILITIES

#### LA COMBINAISON

Combinez la parka avec la veste polaire et découvrez le confort d'un produit qui s'adapte à tous les aléas du climat !

#### THE COMBINATION

Combine the parka with the fleece jacket and discover the comfort of a product that adapts to all climate hazards!



3→1

ou / or



3→1

**NOTT + PIKKER**  
Parka de pluie HV FR + veste polaire FR  
HV FR rain parka + IFR fleece jacket

**DAGDA + PIKKER**  
Parka de pluie FR + veste polaire FR  
FR rain parka + IFR fleece jacket



# EXPERT

**EXPERT**

# THOR

8MTHJY / 8MTHTY



## AVANTAGES / BENEFITS

- Industries pétrolières et gazières
- Industrie Chimique
- Industrie électrique et automobile
- Services publics / Construction / Aéroport
- LES PLUS: mercerie plastique + composition mélangée
- Oil and gas industries
- Chemical industry
- Electrical and automotive industries
- Utilities / Construction / Airport
- PLUS: plastic trims+ mixed composition



8MTHJY



8MTHTY

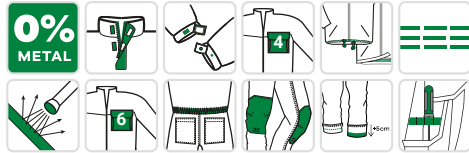

8KNEE

## TISSUS / FABRICS

- SERGÉ FR: 79% Coton / 20% Polyester / 1% Antistatique - 300g/m<sup>2</sup>
- MERCERIE: Plastique
- BANDES RÉTRO-RÉFLÉCHISSANTES FR: Bandes cousues microbilles : 5cm

- FR TWILL: 79% Cotton / 20% Polyester / 1% Antistatic - 300g/m<sup>2</sup>
- TRIMS: Plastic
- FR RETRO-REFLECTIVE BANDS: sewn microbead bands: 5cm

## CARACTÉRISTIQUES / FEATURES

### VESTE / JACKET

- Col montant
- Colletterte de marquage
- Zip central sous rabat à pressions cachées
- Poignets ajustables par pressions
- Pattes de réglage côtés à pressions
- 2 poches poitrine à rabat fermé
- 1 poche intérieure
- 2 poches basses à rabat fermé
- 2 passants porte dosimètre
- 2 soufflets dos
- Triple surpiqûre
- Pictogrammes des normes sur manche
- Bandes cousues: 2 épaules + 2 ceintures + 2 brassards/manche

- High collar
- Marking ruff
- Hidden snaps under central tab
- Cuff adjustable by snaps
- Adjustment tabs with snap sides
- 2 chest pockets with closed flap
- 1 inside pocket
- 2 lower pockets with closed flap
- 2 dosimeter loops
- 2 back gussets
- Triple topstitching
- Standards pictograms on sleeve
- Sewn bands: 2 shoulders + 2 belts + 2 armbands/sleeve

### PANTALON / PANTS

- Ceinture élastiquée côtés + Passants
- Colletterte de marquage dans ceinture
- 2 poches italiennes
- 2 poches dos à rabat fermé
- 1 poche côté à rabat fermé
- 1 poche outils
- Poches genoux en sergé, ouverture par le bas
- EN 14404: Type 2 - Niveau 0
- Triple surpiqûre
- Pictogrammes des normes sur poche
- Ourlet supplémentaire: +5cm
- Bandes cousues : 2 brassards/jambe

- Elasticated back waistband + Loops
- Marking ruff in the inner belt
- 2 italian pockets
- 2 back pockets with closed flap
- 1 side pocket with closed flap
- 1 tool pocket
- Twill kneepad pockets, bottom loading
- EN 14404: Type 2 - Level 0
- Triple topstitching
- Standards pictograms on pocket
- Adjustable leg length: +5cm
- Sewn bands: 2 armbands/leg



EN 20471  
veste et pantalon séparés  
jacket and pants separated



EN 20471  
Veste + pantalon  
Jacket + Pants



EN 13034  
TYPE PB6



EN 1149-5



EN 1161  
CLASS 1 - A1



EN 11612  
A1-B1-C1-E1-F1



IEC 61482-2  
CLASS 1 - 4 KA



EN 14404  
TYPE 2

TAILLES SIZES	S	M	L	XL	2XL	3XL
VESTE JAUNE HV / MARINE JACKET HV YELLOW / NAVY BLUE	8MTHJYS	8MTHJYM	8MTHJYL	8MTHJYXL	8MTHJYXXL	8MTHJYXXXL
PANTALON JAUNE HV / MARINE PANTS HV YELLOW / NAVY BLUE	8MTHTYS	8MTHTYM	8MTHTYL	8MTHTYXL	8MTHTYXXL	8MTHTYXXXL
CONDITIONNEMENT PACKAGING	Emballage individuel ou par 10 / Individual pack or per 10					

# THOR

8MTHCY



## AVANTAGES / BENEFITS

- Industries pétrolières et gazières
- Industrie chimique
- Industries électriques et automobiles
- Services publics
- Construction
- Aéroport
- LES PLUS: mercerie plastique + composition mélangée
- Oil and gas industries
- Chemical industry
- Electrical and automotive industries
- Utilities
- Construction
- Airport
- PLUS: plastic trims+ mixed composition

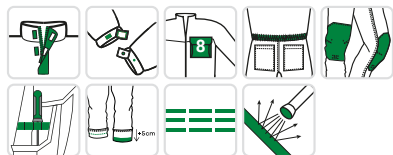

8MTHCY



8KNEE

## TISSUS / FABRICS

- SERGÉ FR: 79% Coton / 20% Polyester / 1% Antistatique - 300g/m<sup>2</sup>
- MERCERIE: Plastique
- BANDES RÉTRO-RÉFLÉCHISSANTES FR: Bandes cousues microbilles : 5cm

- FR TWILL: 79% Cotton / 20% Polyester / 1% Antistatic - 300g/m<sup>2</sup>
- TRIMS: Plastic

- FR RETRO-REFLECTIVE BANDS: sewn microbead bands: 5cm

## CARACTÉRISTIQUES / FEATURES

- Col montant
- Colletterie de marquage
- Zip central sous rabat à pressions cachées
- Ceinture élastiquée dos
- Poignets ajustables par pressions
- 2 poches poitrine à rabat fermé
- 1 poche intérieure
- 2 poches italiennes
- 2 poches dos à rabat fermé
- 1 poche côté à rabat fermé
- 1 poche outils à rabat fermé
- 2 passants porte dosimètre
- Poches genoux en sergé, ouverture par le bas
- EN 14404: Type 2 - Niveau 0
- 2 soufflets do
- Triple surpiqûre
- Pictogrammes des normes sur manche
- Ourlet supplémentaire: +5cm
- Bandes cousues: 2 épaules + 2 ceintures + 2 brassards/manche + 2 brassards/jambe

- High collar
- Marking ruff
- Hidden snaps under central tab
- Elasticated back waistband
- Cuff adjustable by snaps
- 2 chest pockets with closed flap
- 1 inside pocket
- 2 italian pockets
- 2 back pockets with closed flap
- 1 side pocket with closed flap
- 1 tool pocket with closed flap
- 2 dosimeter loops
- Twill kneepad pockets, bottom loading
- EN 14404: Type 2 - Level 0
- 2 back gussets
- Triple topstitching
- Standards pictograms on sleeve
- Adjustable leg length: +5cm
- Sewn bands: 2 shoulders + 2 belts + 2 armbands/sleeve + 2 armbands/leg



EN 20471



EN 14404  
TYPE 2 - NIVEAU 0



EN 13034  
TYPE 6



EN 1149-5



EN 11611  
CLASS 1 - A1



EN 11612  
AI-B1-C1-E1-F1



IEC 61482-2  
CLASS 1 - 4 KA

TAILLES SIZES	S	M	L	XL	2XL	3XL
JAUNE HV / MARINE HV YELLOW / NAVY BLUE	8MTHCYS	8MTHCYM	8MTHCYL	8MTHCYXL	8MTHCYXXL	8MTHCYXXXL
CONDITIONNEMENT PACKAGING	Emballage individuel ou par 10 / Individual pack or per 10					



PARKA / PARKA

# NOTT

5NOT16



## AVANTAGES / BENEFITS

- IMPERMÉABLE: Coque de pluie 8 000mm avec coutures étanchées + capuche
- FONCTIONNELLE: se porte toute l'année avec ou sans la doublure additionnelle polaire PIKKER
- VISIBILITÉ: EN 20471 Classe 3
- WATERPROOF: 8 000mm rain shell with taped seams + hood
- FUNCTIONAL: can be worn all year round with or without the additional PIKKER fleece liner
- VISIBILITY: EN 20471 Class 3

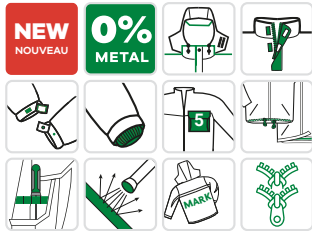

## TISSUS / FABRICS

- OXFORD FR: 98% Polyester / 2% Fibre antistatique enduit polyuréthane - 250g/m<sup>2</sup>
- BORD-CÔTES FR: 100% Polyester - 520 g/m<sup>2</sup>
- DOUBLURE FR: 100% Coton - 160g/m<sup>2</sup>
- MERCERIES: Plastiques
- IMPERMÉABILITÉ : 8 000mm
- Respirabilité : 5 000g/m<sup>2</sup>/24h
- BANDES RÉTRO-RÉFLÉCHISSANTES FR: Bandes cousues microbilles: 5cm
- OXFORD FR: 98% Polyester / 2% Antistatic fiber, Polyurethane coated - 250g/m<sup>2</sup>
- FR RIB: 100% Polyester - 520 g/m<sup>2</sup>
- FR LINING: 100% Cotton - 160g/m<sup>2</sup>
- TRIMS: Plastics
- WATERPROOFNESS : 8 000mm
- BREATHABILITY : 5 000g/m<sup>2</sup>/24h
- FR RETRO-REFLECTIVE BANDS: sewn microbead bands: 5cm

## CARACTÉRISTIQUES / FEATURES

- Coutures étanchées
- Capuche tempête intégrée dans le col + cordon de serrage élastique
- Col montant
- Zip central à double curseur sous rabat à scratchs
- Protège menton
- Poignets coupe-vent en bord-côte
- Poignets réglables par scratch
- Bas réglable par cordon élastique
- 2 poches basses zippées sous passepoil
- 1 poche Napoléon
- 2 poches plaquées intérieures fermées par scratch
- 2 passants porte dosimètre
- Zips + attaches pour fixation de la veste PIKKER
- 1 boucle passe écouteur intérieure
- Bandes cousues: 2 bretelles + 2 ceintures + 2 brassards/manche
- Accès pour marquage
- Taped seams
- Storm hood integrated into collar + elastic drawcord
- High collar
- Central two-way zip under flap with velcro
- Chin guard
- Ribbed windproof cuffs
- Adjustable cuffs by velcro
- Adjustable hemline with elastic drawcord
- 2 lower zipped pockets under piping
- 1 Napoleon pocket
- 2 inside patch pockets closed by velcro
- 2 dosimeter loops
- Zippers + fasteners for attaching the PIKKER jacket
- 1 earphone loop inside
- Sewn bands: 2 straps + 2 belts + 2 armbands/sleeve
- Branding access



TAILLES SIZES	S	M	L	XL	2XL	3XL
JAUNE HV / MARINE HV YELLOW / NAVY BLUE	5NOT16000S	5NOT16000M	5NOT16000L	5NOT1600XL	5NOT1602XL	5NOT1603XL
CONDITIONNEMENT PACKAGING	Emballage individuel ou par 10 / Individual pack or per 10					

EN 14116  
INDEX 3 INNER /  
INDEX 1 OUTER



# PIKKER

5PIK12



## AVANTAGES / BENEFITS

- FONCTIONNELLE: peut être porté seule ou en doublure des parkas NOTT et DAGDA
- CHAUDE: Polaire 300g/m<sup>2</sup>
- CONTRE LES RISQUES THERMIQUES: EN 11612 + IEC 61482
- FUNCTIONAL: can be worn alone or as a lining for NOTT and DAGDA parkas
- WARM: 300g/m<sup>2</sup> fleece
- AGAINST THERMAL HAZARDS: EN 11612 + IEC 61482



## TISSUS / FABRICS

- POLAIRE FR: 60% Modacrylique / 38 % Coton / 2 % Fibre antistatique - 300g/m<sup>2</sup>
- MERCERIE: Plastique FR

- IFR FLEECE: 60% Modacrylic / 38 % Cotton / 2 % Antistatic - 300g/m<sup>2</sup>
- TRIMS: FR plastic

## CARACTÉRISTIQUES / FEATURES

- Col montant
- Zip central
- Poignets élastiqués
- 2 poches basses zippées

- High collar
- Central zip
- Elasticated cuffs
- 2 lower zippered pockets

TAILLES SIZES	S	M	L	XL	2XL	3XL
	5PIK12000S	5PIK12000M	5PIK12000L	5PIK1200XL	5PIK1202XL	5PIK1203XL
CONDITIONNEMENT PACKAGING	Emballage individuel ou par 10 / Individual pack or per 10					



EN 1149-5



EN 11612  
A1-B1-C2-F2



IEC 61482-2  
APC 1



# EKHI

5EKH160



## AVANTAGES / BENEFITS

- **PERFORMANT:** retardateur de flamme inhérent
- **CONFORT:** peut se porter toute l'année grâce à son poids: 180g/m<sup>2</sup>
- **VISIBILITÉ:** Normée EN 20471 classe 2
- **PERFORMING:** inherent flame retardant
- **COMFORT:** can be worn all year round thanks to its weight: 180g/m<sup>2</sup>
- **VISIBILITY:** EN 20471 class 2 standard



## TISSUS / FABRICS

- **JERSEY FR:** 60% Modacrylique / 39% Coton / 1% Fibre antistatique UPF50 - 180g/m<sup>2</sup>
- **BORD-CÔTES FR:** 60% Modacrylique / 39% Coton / 1% Fibre antistatique - 500g/m<sup>2</sup> (col)
- **BORD-CÔTES FR:** 57% Modacrylique / 37% Coton / 5% Élasthanne / 1% Fibre antistatique - 280g/m<sup>2</sup> (poignets)
- **MERCERIE:** Plastique FR
- **IFR JERSEY:** 60% Modacrylic / 39% Cotton / 1% Antistatic fiber UPF50 - 180g/m<sup>2</sup>
- **IFR RIB:** 60% Modacrylic / 39% Cotton / 1% Antistatic fiber - 500g/m<sup>2</sup> (collar)
- **IFR RIB:** 57% Modacrylic / 37% Cotton / 5% Elastane / 1% Antistatic fiber - 280g/m<sup>2</sup> (cuffs)
- **TRIMS:** FR plastic
- **BANDES RÉTRO-RÉFLÉCHISSANTES FR:** Bandes cousues microbilles FR: 5 cm
- **FR RETRO-REFLECTIVE BANDS:** sewn microbead bands: 5cm

## CARACTÉRISTIQUES / FEATURES

- Col polo
- Manches longues
- Pictogrammes de normes sur manche
- Bandes cousues: 2 bretelles + 1 ceinture + 2 brassards/manche
- Polo collar
- Long sleeves
- Standards pictograms on sleeve
- Sewn bands: 2 straps + 1 belt + 2 armbands/sleeve

TAILLES SIZES	S	M	L	XL	2XL	3XL
JAUNE HV / MARINE HV YELLOW / NAVY BLUE	5EKH16000S	5EKH16000M	5EKH16000L	5EKH1600XL	5EKH1602XL	5EKH1603XL
CONDITIONNEMENT PACKAGING	Emballage individuel ou par 20 / Individual pack or per 20					



EN 1149-5



EN 11612  
A1-B1-C1

# HODER

5HOD16 / 5HOD17



## AVANTAGES / BENEFITS

- RÉGLABLE: peut être ajusté en largeur
- VISIBLE: 4 bandes
- ADJUSTABLE: can be adjust in width
- VISIBILITY: 4 bands



5HOD16



5HOD17

## TISSUS / FABRICS

- 98% Polyester + 2% fibre antistatique - 120g/m<sup>2</sup>

- BANDES RÉTRO-RÉFLÉCHISSANTES FR: Bandes cousues microbilles: 5cm

- 98% Polyester + 2% Antistatic fiber - 120g/m<sup>2</sup>

- FR RETRO-REFLECTIVE BANDS: sewn microbead bands: 5cm

## CARACTÉRISTIQUES / FEATURES

- Fermeture par scratchs ajustables
- Bandes cousues: 2 bretelles + 2 ceintures
- NB lavages : 5

- Closing by velcro
- Sewn bands: 2 braces + 2 belts
- NB washes: 5

TAILLES SIZES	L
JAUNE HV HV YELLOW	5HOD16000L
ORANGE HV HV ORANGE	5HOD17000L
CONDITIONNEMENT PACKAGING	Emballage par 10 ou par 50 / Packaging per 10 or per 50



EN 20471



EN 1149-5



EN 14116  
INDEX 1







# VISIBILITÉ MODÉRÉE

**WARM** WEATHER

VESTE / JACKET

# VIGILE

5VIG010



**AVANTAGES / BENEFITS**

- Forte imperméabilité
- Coupe-vent
- Visibilité accrue: EN 17353
- High waterproofness
- Windbreaker
- Moderates Visibility: EN 17353

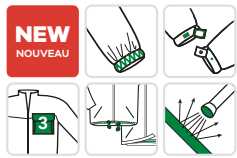

**TISSUS / FABRICS**

- SOFTSHELL 3 COUCHES: 100% Polyester stretch mécanique + Membrane TPU + Micro-polaire - 330g/m<sup>2</sup>
- 3-LAYER SOFTSHELL: 100% Polyester mechanical stretch + TPU membrane + Microfleece - 330g/m<sup>2</sup>
- IMPERMÉABILITÉ : 8 000 mm
- WATERPROOFNESS : 8 000 mm
- RESPIRABILITÉ : 800 g/m<sup>2</sup>/24h
- BREATHABILITY : 800 g/m<sup>2</sup>/24h
- BANDES RÉTRO-RÉFLÉCHISSANTES : Bandes cousues microbilles: 5cm
- RETRO-REFLECTIVE BANDS: swen microbead bands: 5cm

PARKA / PARKA

# SECURITE

5SEC010



**AVANTAGES / BENEFITS**

- PRATIQUE : multipoches
- VISIBILITÉ MODÉRÉE : EN 17353
- CONSERVE LA CHALEUR : matelassage élevé
- FUNCTIONAL: Mulpockets
- MODERATE VISIBILITY : EN 17353
- KEEP WARM: high density quilting



EN 14058



EN 343

**TISSUS / FABRICS**

- OXFORD: 100% Polyester enduit Polyuréthane - 300D
- OXFORD: 100% Polyester, Polyurethane coated - 300D
- MATELASSAGE : 100% Polyester - 160g/m<sup>2</sup> (corps) - 140g/m<sup>2</sup> (manches)
- PADDING: 100% polyester - 160g/m<sup>2</sup> (body) - 140g/m<sup>2</sup> (sleeves)
- DOUBLURE TAFFETAS: 100% Polyester - 60g/m<sup>2</sup>
- TAFFETA LINING: 100% Polyester - 60g/m<sup>2</sup>
- DOUBLURE POLAIRE: 100% Polyester (col)
- FLEECE LINING: 100% Polyester (collar)
- IMPERMÉABILITÉ : 2 000 mm
- WATERPROOFNESS : 2 000 mm
- BANDES RÉTRO-RÉFLÉCHISSANTES : Bandes cousues microbilles: 5cm
- RETRO-REFLECTIVE BANDS: swen microbead bands: 5cm

# RAINET

5RAI08



## AVANTAGES / BENEFITS

- UN BASIQUE
- VISIBILITÉ MODÉRÉE: bandes rétro réfléchissantes
- ISOLATION: Poignets coupe-vent
- A BASIC
- MODERATE VISIBILITY: retroreflective bands
- INSULATION: windproof cuffs



## TISSUS / FABRICS

- 100% Polyester enduit PVC souple - 200g/m<sup>2</sup>
- IMPERMÉABILITÉ : 2 000 mm
- BANDES RÉTRO-RÉFLÉCHISSANTES : Bandes cousues microbilles: 5cm



- 100% Polyester, soft PVC coated - 200g/m<sup>2</sup>
- WATERPROOFNESS : 2 000 mm
- RETRO-REFLECTIVE BANDS: sewn microbead bands : 5cm

## MANTEAU / COAT

# RAINET COAT

5RAC120



## AVANTAGES / BENEFITS

- UN BASIQUE
- VISIBILITÉ MODÉRÉE: bandes rétro réfléchissantes
- ISOLATION: Poignets coupe-vent
- A BASIC
- MODERATE VISIBILITY: retroreflective bands
- INSULATION: windproof cuffs



## TISSUS / FABRICS

- 100% Polyester enduit PVC souple - 200g/m<sup>2</sup>
- IMPERMÉABILITÉ : 2 000 mm
- BANDES RÉTRO-RÉFLÉCHISSANTES : Bandes cousues microbilles: 5cm



- 100% Polyester, soft PVC coated - 200g/m<sup>2</sup>
- WATERPROOFNESS : 2 000 mm
- RETRO-REFLECTIVE BANDS: sewn microbead bands : 5cm

PARKA / PARKA

# DAGDA

5DAG12



## AVANTAGES / BENEFITS

- IMPERMÉABLE: Coque de pluie 8 000mm avec coutures étanchées + capuche
- FONCTIONNELLE: se porte toute l'année avec ou sans la doublure additionnelle PIKKER
- VISIBILITÉ: Normée EN 17353
- WATERPROOF: 8 000mm rain shell with taped seams + hood
- FUNCTIONAL: can be worn all year round with or without the additional PIKKER fleece liner
- VISIBILITY: EN 17353 standard

0%  
METAL



## TISSUS / FABRICS

- OXFORD FR: 98% Polyester / 2% Fibre antistatique enduit polyuréthane - 250g/m<sup>2</sup>
- DOUBLURE FR: 100% Coton - 160g/m<sup>2</sup>
- MERCERIES: Plastiques
- IMPERMÉABILITÉ : 8 000 mm
- RESPIRABILITÉ : 5 000 g/m<sup>2</sup>/24h
- BANDES RÉTRO-RÉFLÉCHISSANTES FR : Bandes cousues microbilles: 5cm

- OXFORD FR: 98% Polyester / 2% Antistatic fiber, Polyurethane coated - 250g/m<sup>2</sup>
- FR LINING: 100% Cotton - 160g/m<sup>2</sup>
- TRIMS: Plastics
- WATERPROOFNESS : 8 000 mm
- BREATHABILITY : 5 000 g/m<sup>2</sup>/24h
- FR RETRO-REFLECTIVE BANDS: sewn microbead bands: 5cm



EN 17353  
Type B3



EN 343



EN 13034  
Type PB6



EN 14116  
Index 3 inner /  
index 1 outer

## VESTE SOFTSHELL / SOFTSHELL JACKET

# TUISTO

5TUI20



## AVANTAGES / BENEFITS

- IMPERMÉABLE: membrane à 8 000mm
- VISIBILITÉ: Normée EN 17353
- CHAUDE: intérieure laminée en polaire
- WATERPROOF: membrane at 8 000mm
- VISIBILITY: EN 17353 standard
- WARM: laminated fleece inside

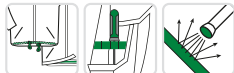

## TISSUS / FABRICS

- SOFTSHELL 3 COUCHES FR: 100% Polyester + Membrane PU + 60% Modacrylique / 39% Coton / 1% Fibre antistatique - 320g/m<sup>2</sup>
- MERCERIE: Plastique
- IMPERMÉABILITÉ : 8 000 mm
- BANDES RÉTRO-RÉFLÉCHISSANTES FR : Bandes cousues microbilles: 5cm

- FR 3-LAYER SOFTSHELL: 100% Polyester + PU membrane + 60% Modacrylic / 39% Cotton / 1% Antistatic fiber - 320g/m<sup>2</sup>
- TRIMS: Plastic
- WATERPROOFNESS : 8 000 mm
- FR RETRO-REFLECTIVE BANDS: swen microbead bands: 5cm



EN 17353  
Type B3



EN 13034  
Type PB6



EN 11612  
A1+A2-B1-C1-F1



IEC 61482-2  
APC 1 - 4kA  
ELIM 17cal/cm<sup>2</sup>





# ACCESSOIRES

**ACCESSORIES**

**BRASSARD / ARMAND**

# KOUKOU

5KOU16\*



**AVANTAGES / BENEFITS**

- Plusieurs types d'éclairage
- Piles remplaçables
- Normé
- *Several types of lighting*
- *Replaceable batteries*
- *Standard*

**TISSUS / FABRICS**

- OXFORD: 100% Polyester enduit Polyuréthane - 300D
- IMPERMÉABILITÉ : 1500 mm
- BANDES RÉTRO-RÉFLÉCHISSANTES 3M® : Bandes cousues microbilles : 5 cm
- OXFORD: 100% Polyester, Polyurethane coated - 300D
- WATERPROOFNESS : 1500 mm
- RETRO-REFLECTIVE BANDS 3M® : sewn microbead bands : 5cm

**CARACTÉRISTIQUES / FEATURES**

- Ajustable par scratch
- 5 LED 3 modes d'éclairage Fonctionne avec 2 piles
- Mixe matière fluorescente + rétro-réfléchissante
- EN 13356 : type 2
- *Adjustable by velcro*
- *5 LEDs - 3 lighting mode - Works with 2 batteries*
- *Mix of fluorescent + retro-reflective material*
- *EN 13356: type 2*



5KOU16NSI



TAILLES SIZES	TAILLE UNIQUE UNIQUE SIZE
JAUNE HV HV YELLOW	5KOU16NSI
CONDITIONNEMENT PACKAGING	Brochable : unitaire / Hangable: single

\* Dans la limite des stocks disponibles / Within the limit of the available stock

**BRASSARD / ARMAND**

# ARMYARD

7ARMG\* / 7ARMY\* / 7ARMO\*



**AVANTAGES / BENEFITS**

- Bonne visibilité
- *Good visibility*



7ARMG



7ARMY



7ARMO

**TISSUS / FABRICS**

- OXFORD: 100% Polyester enduit Polyuréthane - 300D
- BANDES RÉTRO-RÉFLÉCHISSANTES 3M® : Bandes cousues microbilles : 5cm
- OXFORD: 100% Polyester, Polyurethane coated - 300D
- RETRO-REFLECTIVE BANDS 3M® : sewn microbead bands : 5cm

**CARACTÉRISTIQUES / FEATURES**

- L: 45cm - H: 10cm
- Ajustable par scratch
- Mixe matière fluorescente + rétro-réfléchissante
- EN 13356: type 2
- *L: 45cm - H: 10cm*
- *Adjustable by velcro*
- *Mix of fluorescent + retro-reflective material*
- *EN 13356: type 2*



TAILLES SIZES	TAILLE UNIQUE UNIQUE SIZE
VERT HV HV GREEN	7ARMG
JAUNE HV HV YELLOW	7ARMY
ORANGE HV HV ORANGE	7ARMO
CONDITIONNEMENT PACKAGING	(lot de 10): par 1 ou par 20 / (batch of 10): per 1 or per 20

\* Dans la limite des stocks disponibles / Within the limit of the available stock

# BARRICADE TAPE

MO70010



## AVANTAGES / BENEFITS

- Résistant lors de l'étirement
- Resistant when stretched

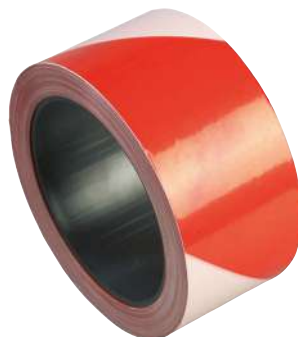

70010

## TISSUS / FABRICS

- Polyéthylène non adhésif
- Non-adhesive polyethylene

## CARACTÉRISTIQUES / FEATURES

- L: 100 m - l: 5cm
- L: 100 m - w: 5cm

TAILLES SIZES	TAILLE UNIQUE UNIQUE SIZE
ROUGE / BLANC RED / WHITE	70010
CONDITIONNEMENT PACKAGING	(lot de 10): par 1 ou par 25 / (batch of 10): per 1 or per 25

# TRAFFIC CONE

MO70300



## AVANTAGES / BENEFITS

- Signalisation routière
- Road signs



70303



70300

## TISSUS / FABRICS

- Polyéthylène
- Polyethylene

## CARACTÉRISTIQUES / FEATURES

- Existe en 30 et 50cm
- Available in 30 and 50cm

TAILLES SIZES	30 CM	50 CM
ROUGE / BLANC RED / WHITE	70303	70300
CONDITIONNEMENT PACKAGING	70303 : 20 cônes par carton / 20 cones per box 70300 : 10 cônes par carton / 10 cones per box	

**LAMPES FRONTALE / HEAD LAMP**

**LED**

71950



**AVANTAGES / BENEFITS**

- Résistance (intempéries, chutes de moins d'un mètre).
- Praticité (anti-glissement, angle ajustable).
- Resistance (bad weather, falls of less than a metre).
- Convenient (anti-slip, adjustable angle)



DESCRIPTION	71955	71950
PILES / BATTERIES	1 x AAA	3 x AAA
SOURCES LUMINEUSES / LIGHT SOURCES	CREE® XP-E LED	CREE® XP-E LED
DIMENSIONS	58 x 29 x 22 mm	60 x 48 x 30 mm
POIDS (SANS LES PILES) / WEIGHT (WITHOUT BATTERIES)	19 g	32 g
PUISSANCES D'ÉCLAIRAGE / LIGHTING POWER	100 lm	150 lm
DURÉES D'ÉCLAIRAGE / LIGHTING TIME	3h00	8h00
DISTANCES DE FAISCEAU / BEAM DISTANCES	80 m	100 m
GRIPS ANTI-GLISSE / ANTI-SLIP GRIPS	Oui / Yes	Oui / Yes
ANGLES RÉGLABLES / ADJUSTABLE ANGLES	Oui / Yes	Oui / Yes
RÉSISTANCE À LA CHUTE / RESISTANCE TO FALLING	1 m	1 m

**REACH  
RoHS**



EN 60529 IPX4  
EN 55015 : 2013  
EN 61547 : 2009

CONDITIONNEMENT : par 6 ou par 24 / PACKAGING: per 6 or per 24

**LED**

71920



**AVANTAGES / BENEFITS**

- Compatibilité ATEX
- Visibilité (jaune fluo)
- Praticité (anti-glissement, angle ajustable).
- ATEX compatibility.
- Visibility (fluorescent yellow)
- Convenient (anti-slip, adjustable angle)



DESCRIPTION	71920	
PILES / BATTERIES	1 x AAA	
SOURCES LUMINEUSES / LIGHT SOURCES	CREE® XP-G2 LED	
DIMENSIONS	80 x 50 x 45 mm	
POIDS (SANS LES PILES) / WEIGHT (WITHOUT BATTERIES)	143 g	
2 MODES D'ÉCLAIRAGE / 2 LIGHTING MODES	Courte portée / Short range	Longue portée / Long range
PUISSANCES D'ÉCLAIRAGE / LIGHTING POWER	75 lm	200 lm
DURÉES D'ÉCLAIRAGE / LIGHTING TIME	4h30	2h30
DISTANCES DE FAISCEAU / BEAM DISTANCES	75 m	100 m
GRIP ANTI-GLISSE / ANTI-SLIP GRIP	Oui / Yes	
ANGLE RÉGLABLE / ADJUSTABLE ANGLE	Oui / Yes	
RÉSISTANCE À LA CHUTE / RESISTANCE TO FALLING	1 m	

**REACH  
RoHS**



EN 60529 IP67  
EN 55015 : 2013  
EN 61547 : 2009

CONDITIONNEMENT : par 5 ou par 30 / PACKAGING: per 5 or per 30.

**ATEX**

71900

**AVANTAGES / BENEFITS**

- Compatibilité ATEX.
- Résistance (eau, chocs)
- Visibilité (jaune fluo)
- ATEX compatibility
- Resistance (water, shocks)
- Visibility (fluorescent yellow)

**ATEX**

71910\*

**AVANTAGES / BENEFITS**

- Compatibilité ATEX.
- Résistance (plongée)
- Visibilité (jaune fluo)
- ATEX compatibility
- Resistance (diving)
- Visibility (fluorescent yellow)

**REACH ROHS** EN 60529 IP67  
EN 55015 : 2013  
EN 61547 : 2009**REACH ROHS** EN 60529 IP68  
EN 55015 : 2013  
EN 61547 : 2009

DESCRIPTION	71900	
PILES / BATTERIES	4 x AA (LR6)	
SOURCES LUMINEUSES LIGHT SOURCES	CREE® XP-E LED	
DIMENSIONS	174 x 47 x 47 mm	
POIDS (SANS LES PILES) WEIGHT (WITHOUT BATTERIES)	115 g	
2 MODES D'ÉCLAIRAGE 2 LIGHTING MODES	Courte portée / Short range	Longue portée / Long range
PUISSANCES D'ÉCLAIRAGE LIGHTING POWER	31 lm	120 lm
DURÉES D'ÉCLAIRAGE LIGHTING TIME	69h10	6h00
DISTANCES DE FAISCEAU BEAM DISTANCES	85 m	172 m
CLIP D'ATTACHE FASTENER CLIP	Oui / Yes	

CONDITIONNEMENT : par 12 ou par 48 / PACKAGING: per 12 or per 48.

DESCRIPTION	71910	
PILES / BATTERIES	4 x AA (LR6)	
SOURCES LUMINEUSES LIGHT SOURCES	CREE® XP-E LED	
DIMENSIONS	172 x 47 x 47 mm	
POIDS (SANS LES PILES) WEIGHT (WITHOUT BATTERIES)	140 g	
3 MODES D'ÉCLAIRAGE 3 LIGHTING MODES	Clignotant / Flash	
	Courte portée / Short range	Longue portée / Long range
PUISSANCES D'ÉCLAIRAGE LIGHTING POWER	62 lm	157 lm
DURÉES D'ÉCLAIRAGE LIGHTING TIME	13h00	6h10
DISTANCES DE FAISCEAU BEAM DISTANCES	83 m	117 m
CLIP D'ATTACHE FASTENER CLIP	Oui / Yes	

CONDITIONNEMENT : par 10 ou par 50 / PACKAGING: per 10 or per 50.

# SÉLECTIONNER SA TAILLE / PICK UP THE CORRECT SIZE

## PRENDRE SES MESURES / TAKE YOUR MEASURES

Le tableau de correspondance ci-dessous inclut les mensurations + l'aisance nécessaire à la bonne pratique de son métier.  
The correspondence table below includes the measurements plus the ease required to practice one's trade.

Les mesures se prennent en centimètres, horizontalement, à l'aide d'un mètre ruban, plaqué sur le corps sans le serrer.  
Measurements are taken in centimetres, horizontally, using a tape measure, plated on the body without tightening it.

### + TOUR DE POITRINE / HIGH CHEST SIZE

- Le tour de poitrine se prend au point le plus fort de la poitrine.
- High chest size has to be taken at the strongest point of the chest

### + TOUR DE TAILLE / WAIST SIZE

- Le tour de taille se prend au point le plus étroit du buste.
- Waist size has to be taken at the narrowest point of the bust.

### + TOUR DE CEINTURE / BELT SIZE

- Le tour de ceinture se prend au niveau de la taille basse/posée sur l'os iliaque.
- Belt size has to be taken from the lower waist/placed on the iliac bone.

### + TOUR DE BASSIN / HIPS SIZE

- Le tour de bassin se prend au point le plus fort des hanches/ bien passer sur la zone la plus bombée du dos térier.
- Hips size has to be taken at the strongest point of the hips/ over the most curved area of the posterior.

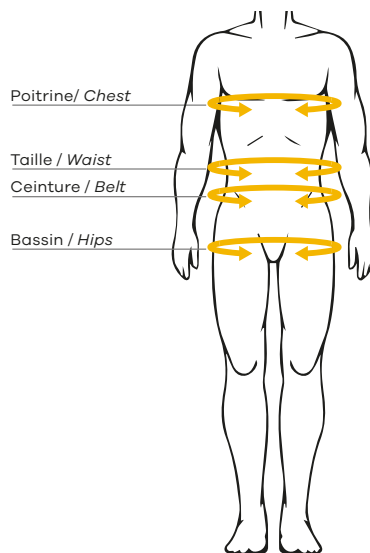

## TABLEAU DE CORRESPONDANCE / CORRESPONDANCE TABLE

### + FEMME / WOMEN

MENSURATIONS MEASUREMENTS	XS	S	M	L	XL	2XL
HAUT / TOP	34 - 36	38 - 40	42 - 44	46 - 48	50 - 52	54 - 56
POITRINE / CHEST	75 - 81	82 - 87	88 - 93	94 - 99	100 - 105	106 - 112
TAILLE / WAIST	62 - 68	69 - 74	75 - 80	81 - 86	87 - 92	93 - 99
BAS / BOTTOM	32 - 34	36 - 38	40 - 42	44 - 46	48 - 50	52 - 54
TAILLE / WAIST	62 - 68	69 - 74	75 - 80	81 - 86	87 - 92	93 - 99
BASSIN / HIPS	84 - 90	91 - 96	97 - 102	103 - 108	109 - 114	115 - 121

### + CONSEIL / ADVICE

Il est conseillé de commander la taille correspondante à la plus grande des mensurations.  
Il est recommandé d'axer le choix de sa taille selon ses mensurations et non selon les équivalences en taille française qui restent des valeurs indicatives.  
En cas de doute, l'usage d'un vestiaire est recommandé.

*It is advised to order the size corresponding to the largest of your measurements.  
It is recommended to choose your size according to your own measurements and not according to the equivalences in French size which remain indicative values.  
In case of doubt, the use of a wardrobe is recommended.*

### + HOMME / MEN

MENSURATIONS MEASUREMENTS	XS	S	M	L	XL	2XL	3XL	4XL	5XL	6XL
HAUT / TOP	36 - 38	40 - 42	44 - 46	48 - 50	52 - 54	56 - 58	60 - 62	64 - 66	68 - 70	72 - 74
POITRINE / CHEST	78 - 85	86 - 93	94 - 101	102 - 109	110 - 117	118 - 125	126 - 133	134 - 141	142 - 149	150 - 157
TAILLE / WAIST	68 - 75	76 - 83	84 - 91	92 - 99	100 - 107	108 - 115	116 - 123	124 - 131	132 - 139	140 - 147
BAS / BOTTOM	34 - 36	38 - 40	42 - 44	46 - 48	50 - 52	54 - 56	58 - 60	62 - 64	66 - 68	70 - 72
TAILLE / WAIST	68 - 75	76 - 83	84 - 91	92 - 99	100 - 107	108 - 115	116 - 123	124 - 131	132 - 139	140 - 147
BASSIN / HIPS	84 - 91	92 - 99	100 - 107	108 - 115	116 - 123	124 - 131	132 - 139	140 - 147	148 - 155	156 - 163

Le bien-aller du vêtement varie selon la coupe, la matière et la morphologie du porteur.  
The fit of the garment may vary according to the cut, fabric and the wearer's morphology.

Pour plus d'informations, rendez-vous sur [www.coverguard-safety.com](http://www.coverguard-safety.com)  
Please visit [www.coverguard-safety.com](http://www.coverguard-safety.com) for more information.

# PICTOGRAMMES / PICTOGRAMS



NOUVEAU  
NEW



NOUVELLE  
COULEUR  
NEW COLOR



CAPUCHE  
TEMPÊTE  
STORM HOOD



CAPUCHE X PANS  
HOOD X PANELS



RABAT CENTRAL  
ZIPPER VELCRO  
FLAP



MANCHES  
AMOVIBLES  
REMOVABLE  
SLEEVES



POIGNETS  
ÉLASTIQUÉS  
ELASTICATED CUFFS



POIGNETS  
RÉGLABLES  
ADJUSTABLE CUFFS



POIGNETS  
COUPE VENT  
WINDPROOF  
CUFFS



NB POCHEs  
NB POCKETS



CEINTURE  
ÉLASTIQUÉE  
ELASTICATED  
WAISTBAND



SERRAGE  
TIGHTENING



DOS ÉLASTIQUÉ  
ELASTICATED BACK



PROTÈGE REINS  
KIDNEY  
PROTECTION



BRETELLES  
AJUSTABLES  
ADJUSTABLE  
BRACES



BRETELLES  
AMOVIBLES  
REMOVABLE  
BRACES



RÉHAUSSE DOS  
BACK  
EXTENSION



PANNEAU  
ENTREJAMBE  
CROTCH GUSSET



PASSE MAIN  
HAND REST



BRAGUETTE  
FLY



POCHES GENOUX  
KNEEPAD  
POCKETS



SERRAGE  
BAS JAMBES  
LOWER LEG  
TIGHTENING



OURLET EN +  
EXTRA HEM



SANGLE OUTILS  
TOOLS LOOP



AÉRATION  
VENTILATION



RESPIRANT  
BREATHABLE



RÉVERSIBLE  
REVERSIBLE



RÉFLÉCHISSANT  
REFLECTIVE



MARQUABLE  
MARKABLE



PRODUIT X EN 1  
PRODUCT X IN 1



FEMME  
WOMAN



SLIM  
COUPE SLIM  
SLIM FIT



STRETCH  
STRETCH  
STRETCH



LÉGER  
LIGHT



CHAUD  
HOT



-45°C  
-45°C



TISSU  
AVEC UPF  
FABRIC  
WITH UPF



ZERO MÉTAL  
METAL FREE



FIBRE ÉCO  
ECO FIBER



TRIPLE PIQÛRE  
TRIPLE STITCHING



COUTURES SOUDÉES  
WELDED SEAMS



ZIP ÉTANCHE  
WATERPROOF  
ZIPPER



ÉTANCHE  
WATERPROOF



GRAPHÈNE  
GRAPHENE



COMBINABLE  
COMBINABLE



SBS



375



YKK



CORDURA



DUFONT  
sorona



3M Scotch-lite  
Adhesive Material

# NOTRE OBJECTIF, ACCÉLÉRER VOTRE PERFORMANCE

→ OUR GOAL, SPEED UP YOUR PERFORMANCE

## Site E-ordering *E-Ordering website*

- Commandes express  
*Fast order processing*
- Information produit (PIM)  
*Product information*
- Visibilité en temps réel des stocks  
*Real-time stock visibility*
- Dates de réapprovisionnement  
*Restocking dates*
- Suivi des commandes  
*Order tracking*
- Espace dédié aux factures et commandes  
*Platform dedicated to invoices and orders*

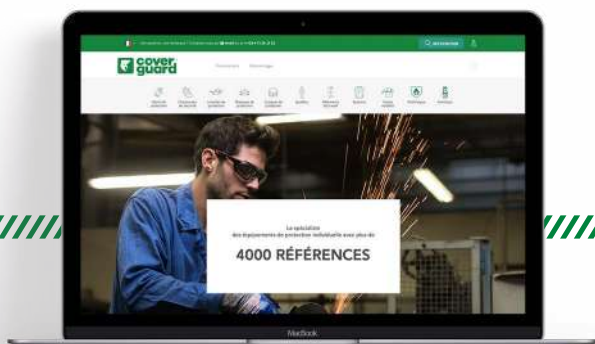

## Espaces clients *Customer areas*

- Showroom de 300m<sup>2</sup>  
*300m<sup>2</sup> showroom*
- Lieux d'échange et de conseil  
*Places of exchange and advice*
- Sessions de formation  
*Training Sessions*
- Plateforme de sensibilisation au travail en hauteur et mise en situation de notre gamme Anti-chute  
*Demonstration of our Fall Protection range and its training module*





# NOTRE

# CULTURE CLIENT

→ OUR CUSTOMER CULTURE

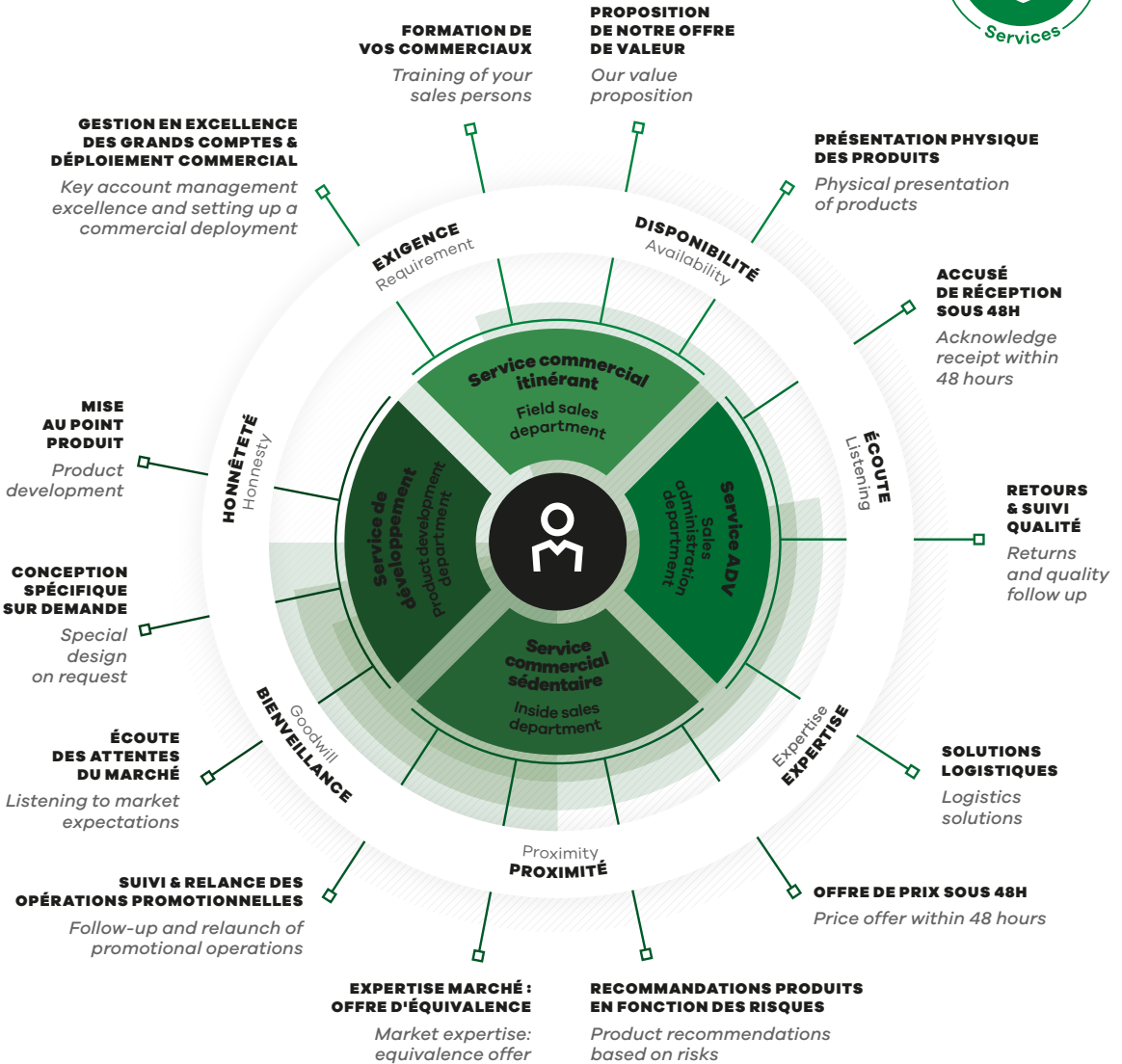

De la gestion de projet au service à la clientèle et jusqu'au service après-vente, notre agilité nous permet de réagir efficacement en restant toujours "centré client" pour vous servir au mieux.

From project management to customer service, not forgetting the after-sales service, our agility allows us to react efficiently, and ensures we always remain customer-centric.

# MOBILIER ÎLOT / ISLAND FURNITURE

**NOUS CONTACTER POUR TOUTE DEMANDE**  
CONTACT US FOR ANY REQUEST

## ➔ CARACTÉRISTIQUES / CHARACTERISTICS

- Mobilier îlot destiné à aménager l'espace central des magasins
- Kit de base obligatoire commun à toutes les configurations
- Mobilier en tôles pliées en acier peint (gris foncé)
- Assemblage rapide sans outil (sauf la traverse haute où il faut 2 écrous)
- Dimensions (largeur x hauteur x profondeur) : 105 cm x 170 cm x 97 cm
- *Island furniture for the central area of shops*
- *Mandatory basic kit common to all configurations*
- *Furniture made of bent steel sheets in painted steel (dark grey)*
- *Quick assembly without tools (except for the high crossbar where 2 nuts are needed)*
- *Dimensions (width x height x depth): 105 cm x 170 cm x 97 cm*

### + CONFIGURATION 1

PENDERIE LATÉRALE /  
SIDE WARDROBE



### + CONFIGURATION 2

PENDERIE FRONTALE /  
FRONT WARDROBE



### + CONFIGURATION 3

ÉTAGÈRES POUR BOX OU VÊTEMENTS PLIÉS /  
SHELVES FOR BOXES OR FOLDED CLOTHES



### + CONFIGURATION 4

CHAUSSURES /  
SHOES



### + CONFIGURATION 5

PRODUITS SUR BROCHES /  
PRODUCTS ON HOOKS



### +

AVANTAGES / BENEFITS

- Module recto et verso
- 5 configurations disponibles
- Configurations recto et verso différentes ou identiques au choix
- Modules imbriquables pour former un linéaire
- Assemblage rapide sans outil
- *Double-sided Module*
- *5 available configurations*
- *Back and front configurations different or the same as desired*
- *Nesting modules to form a shelf space*
- *Quick assembly without tools*

### + OPTION

KIT DE TÊTE DE GONDOLE / GONDOLA HEAD KIT



Petites tablettes / small tabs



Broches doubles / double spindeles



Bras incliné / inclined arm

# PRÉSENTOIRS ET PLV / DISPLAYS AND POS

## + PRÉSENTOIR DE LUNETTES / EYEWEAR DISPLAY

**6PLV600NSI**



### → CARACTÉRISTIQUES / FEATURES

- Support en plexiglass
- Miroir intégré
- Capacité : 6 paires de lunettes
- Dimensions : 18.6 x 17.5 x 59 cm
- *Plexiglass stand*
- *Integrated mirror*
- *Capacity: 6 glasses*
- *Dimensions: 18.6 x 17.5 x 59 cm*

## + PRÉSENTOIR DE COMPTOIR / COUNTERTOP DISPLAY

**MPLVCET018**



### → CARACTÉRISTIQUES / FEATURES

- Présentoir en carton double épaisseur
- 3 broches doubles intégrées (25 cm)
- Dimensions : 51,5 x 25,5 x 52 cm
- *Double-layer cardboard display*
- *3 integrated double hooks (25 cm)*
- *Dimensions: 51.5 x 25.5 x 52 cm*

## + ROLL UP / ROLL UP

NOUS CONSULTER /  
CONTACT US



### → CARACTÉRISTIQUES / CHARACTERISTICS

- Roll up enrouleur
- Toile Décolite M1
- Dimensions : 85 x 10 x 208 cm
- *Roll up winder*
- *M1 Decolite Canvas*
- *Dimensions: 85 x 10 x 208 cm*

## + FLAMME / FLAME

NOUS CONSULTER /  
CONTACT US



### → CARACTÉRISTIQUES / CHARACTERISTICS

- Toile sublimée
- Pied 6 kg
- Hauteur : 240 cm
- *Sublimated canvas*
- *Foot 6 kg*
- *Height: 240 cm*

# INDEX / INDEX

<b>AIRPORT</b>	7AIBO	BLOUSON / BOMBER	<b>55</b>	<b>KANATA</b>	7KANG	PARKA MULTICOUCHES / MULTI-LAYER PARKA	<b>33</b>
<b>AIRPORT</b>	7AIBY	BLOUSON / BOMBER	<b>55</b>	<b>KANATA</b>	7KANO	PARKA MULTICOUCHES / MULTI-LAYER PARKA	<b>33</b>
<b>DAGDA</b>	5DAG12	PARKA / PARKA	<b>112</b>	<b>KANATA</b>	7KANR	PARKA MULTICOUCHES / MULTI-LAYER PARKA	<b>33</b>
<b>EKHI</b>	5EKH160	T-SHIRT & POLO / T-SHIRT & POLO	<b>106</b>	<b>KANATA</b>	7KANY	PARKA MULTICOUCHES / MULTI-LAYER PARKA	<b>33</b>
<b>FLAKE</b>	5FLA160	VESTE / JACKET	<b>49</b>	<b>KANPA</b>	5KPA16	VESTE / JACKET	<b>43</b>
<b>FLAKE</b>	5FLA170	VESTE / JACKET	<b>49</b>	<b>KANPA</b>	5KPA17	VESTE / JACKET	<b>43</b>
<b>GOKKAN</b>	5GOK130	VESTE / JACKET	<b>53</b>	<b>KAWA</b>	5KAW160	ENSEMBLE / SET	<b>73</b>
<b>GOKKAN</b>	5GOK16	VESTE / JACKET	<b>53</b>	<b>KAWA</b>	5KAW170	ENSEMBLE / SET	<b>73</b>
<b>GOKKAN</b>	5GOK17	VESTE / JACKET	<b>53</b>	<b>KAWA COAT</b>	5KWC160	VESTE / JACKET	<b>72</b>
<b>HARBOR</b>	MO70310	PARKA / PARKA	<b>70</b>	<b>KAWA COAT</b>	5KWC170	VESTE / JACKET	<b>72</b>
<b>HARBOR</b>	MO70320	PANTALONS / PANTS	<b>71</b>	<b>KAZAN</b>	5KAJ160	VESTE / JACKET	<b>46</b>
<b>HARBOR</b>	MO70330	PARKA / PARKA	<b>70</b>	<b>KAZAN</b>	5KAJ170	VESTE / JACKET	<b>46</b>
<b>HARBOR</b>	MO70340	PANTALONS / PANTS	<b>71</b>	<b>KAZAN</b>	5KAP160	PARKA / PARKA	<b>66</b>
<b>HI-WAY</b>	MO70500	GILET / BODYWARMER	<b>57</b>	<b>KAZAN</b>	5KAP170	PARKA / PARKA	<b>66</b>
<b>HI-WAY</b>	MO70510	GILET / BODYWARMER	<b>57</b>	<b>KAZAN</b>	5KAS160	VESTE / JACKET	<b>45</b>
<b>HI-WAY</b>	MO70530	VESTE / JACKET	<b>47</b>	<b>KAZAN</b>	5KAS170	VESTE / JACKET	<b>45</b>
<b>HI-WAY</b>	7HWGO	GILET / BODYWARMER	<b>56</b>	<b>KETA</b>	7KETO	PARKA / PARKA	<b>35</b>
<b>HI-WAY</b>	7HWGY	GILET / BODYWARMER	<b>56</b>	<b>KETA</b>	7KETR	PARKA / PARKA	<b>35</b>
<b>HI-WAY</b>	7HWRO	ENSEMBLE / SET	<b>74</b>	<b>KETA</b>	7KETY	PARKA / PARKA	<b>35</b>
<b>HI-WAY</b>	7HWRY	ENSEMBLE / SET	<b>74</b>	<b>KOMO</b>	7KOMO	T-SHIRT / T-SHIRT	<b>84</b>
<b>HI-WAY</b>	7HWXO	VESTE / JACKET	<b>48</b>	<b>KOMO</b>	7KOMR	T-SHIRT / T-SHIRT	<b>84</b>
<b>HI-WAY</b>	7HWXY	VESTE / JACKET	<b>48</b>	<b>KOMO</b>	7KOMY	T-SHIRT / T-SHIRT	<b>84</b>
<b>HIBANA</b>	5HBA130	PANTALONS / PANTS	<b>97</b>	<b>KYRIO</b>	7KYRO	T-SHIRT / T-SHIRT	<b>84</b>
<b>HIBANA</b>	5HBA16	PANTALONS / PANTS	<b>97</b>	<b>KYRIO</b>	7KYRY	T-SHIRT / T-SHIRT	<b>84</b>
<b>HIBANA</b>	5HBA17	PANTALONS / PANTS	<b>97</b>	<b>NEKKI</b>	5NEK160	T-SHIRT / T-SHIRT	<b>85</b>
<b>HIBANA</b>	5HBB160	PANTALONS / PANTS	<b>98</b>	<b>NEKKI</b>	5NEK170	T-SHIRT / T-SHIRT	<b>85</b>
<b>HIBANA</b>	5HBB170	PANTALONS / PANTS	<b>98</b>	<b>NEPPA</b>	5NEP16	GILET / VEST	<b>89</b>
<b>HIBANA</b>	5HBJ130	VESTE / JACKET	<b>96</b>	<b>NEPPA</b>	5NEP17	GILET / VEST	<b>89</b>
<b>HIBANA</b>	5HBJ160	VESTE / JACKET	<b>96</b>	<b>NOTT</b>	5NOT16	PARKA / PARKA	<b>104</b>
<b>HIBANA</b>	5HBJ170	VESTE / JACKET	<b>96</b>	<b>OKI</b>	5OKI160	T-SHIRT / T-SHIRT	<b>87</b>
<b>HIBANA</b>	5HBS160	BERMUDA / BERMUDA	<b>99</b>	<b>OKI</b>	5OKI170	T-SHIRT / T-SHIRT	<b>87</b>
<b>HIBANA</b>	5HBS170	BERMUDA / BERMUDA	<b>99</b>	<b>PATROL</b>	7PAJP	PANTALONS / PANTS	<b>93</b>
<b>HODER</b>	5HOD16	GILET / VEST	<b>107</b>	<b>PATROL</b>	7PAJV	VESTE / JACKET	<b>92</b>
<b>HODER</b>	5HOD17	GILET / VEST	<b>107</b>	<b>PATROL</b>	7PAOP	PANTALONS / PANTS	<b>93</b>
<b>HORA</b>	5HOR160	PARKA / PARKA	<b>40</b>	<b>PATROL</b>	7PAOV	VESTE / JACKET	<b>92</b>
<b>HORA</b>	5HOR170	PARKA / PARKA	<b>40</b>	<b>PIKKER</b>	5PIK12	VESTE / JACKET	<b>105</b>
<b>HOTARU</b>	5HOT16	VESTE / JACKET	<b>62</b>	<b>RAINET</b>	5RAI08	ENSEMBLE / SET	<b>111</b>
<b>HOTARU</b>	5HOT17	VESTE / JACKET	<b>62</b>	<b>RAINET</b>	5RAI12	ENSEMBLE / SET	<b>111</b>
<b>HYDRA</b>	5HYJ16	PARKA / PARKA	<b>68</b>	<b>RAINET COAT</b>	5RAC120	MANTEAU / COAT	<b>111</b>
<b>HYDRA</b>	5HYJ17	PARKA / PARKA	<b>68</b>	<b>RIKKA</b>	5RIK160	T-SHIRT / T-SHIRT	<b>81</b>
<b>HYDRA</b>	5HYP16	PANTALONS / PANTS	<b>69</b>	<b>RIKKA</b>	5RIK170	T-SHIRT / T-SHIRT	<b>81</b>
<b>HYDRA</b>	5HYP17	PANTALONS / PANTS	<b>69</b>	<b>RITTO</b>	5RIT160	VESTE / JACKET	<b>51</b>
<b>HYDRA</b>	7HYDO	ENSEMBLE / SET	<b>77</b>	<b>RITTO</b>	5RIT170	VESTE / JACKET	<b>51</b>
<b>HYDRA</b>	7HYDY	ENSEMBLE / SET	<b>77</b>	<b>ROADWAY</b>	7ROAO	PARKA / PARKA	<b>34</b>
<b>KANATA</b>	7KANA	PARKA MULTICOUCHES / MULTI-LAYER PARKA	<b>33</b>	<b>ROADWAY</b>	7ROAY	PARKA / PARKA	<b>34</b>

<b>ROADWAY 4/1</b>	7ROPO	PARKA MULTICOUCHES / MULTI-LAYER PARKA	<b>29</b>
<b>ROADWAY 4/1</b>	7ROPY	PARKA MULTICOUCHES / MULTI-LAYER PARKA	<b>29</b>
<b>SANGAKU</b>	5SAN16	PARKA / PARKA	<b>65</b>
<b>SANGAKU</b>	5SAN17	PARKA / PARKA	<b>65</b>
<b>SECURITE</b>	5SEC010	PARKA / PARKA	<b>110</b>
<b>SOKOBIE</b>	5SOK16	PARKA / PARKA	<b>38</b>
<b>SOKOBIE</b>	5SOK17	PARKA / PARKA	<b>38</b>
<b>SOUKOU</b>	5SOU160	BLOUSON / BOMBER	<b>54</b>
<b>SOUKOU</b>	5SOU170	BLOUSON / BOMBER	<b>54</b>
<b>STATION</b>	MO70630	VESTE / JACKET	<b>44</b>
<b>STATION</b>	MO70640	VESTE / JACKET	<b>44</b>
<b>STATION</b>	MO70680	VESTE / JACKET	<b>44</b>
<b>STATION</b>	7PSTO	VESTE / JACKET	<b>52</b>
<b>STATION</b>	7PSTY	VESTE / JACKET	<b>52</b>
<b>SUNO</b>	7SUNO	T-SHIRT / T-SHIRT	<b>80</b>
<b>SUNO</b>	7SUNR	T-SHIRT / T-SHIRT	<b>80</b>
<b>SUNO</b>	7SUNY	T-SHIRT / T-SHIRT	<b>80</b>
<b>THOR</b>	8MTHCY	COMBINAISON & ENSEMBLE / COVERALL & SET	<b>103</b>
<b>THOR</b>	8MTHJY	VESTE / JACKET	<b>102</b>
<b>THOR</b>	8MTHTY	PANTALONS / PANTS	<b>102</b>
<b>TUISTO</b>	5TUI120	VESTE / JACKET	<b>112</b>
<b>VIGILE</b>	5VIG010	VESTE / JACKET	<b>110</b>
<b>YARD</b>	MO70206	GILET / VEST	<b>88</b>
<b>YARD</b>	MO70212	GILET / VEST	<b>88</b>
<b>YARD</b>	MO70216	GILET / VEST	<b>88</b>
<b>YARD</b>	MO70226	GILET / VEST	<b>88</b>
<b>YARD</b>	MO70232	GILET / VEST	<b>88</b>
<b>YARD</b>	MO70236	GILET / VEST	<b>88</b>
<b>YARD</b>	MO70242	GILET / VEST	<b>89</b>
<b>YARD</b>	MO70252	GILET / VEST	<b>89</b>
<b>YARD</b>	MO70262	GILET / VEST	<b>89</b>
<b>YARD</b>	MO70265	GILET / VEST	<b>89</b>
<b>YARD</b>	MO70270	T-SHIRT / T-SHIRT	<b>87</b>
<b>YARD</b>	MO70280	T-SHIRT / T-SHIRT	<b>87</b>
<b>YARD</b>	7KIDY	GILET / VEST	<b>90</b>
<b>YARD</b>	7JUNY	GILET / VEST	<b>90</b>
<b>YARD</b>	7YAPY	T-SHIRT / T-SHIRT	<b>82</b>
<b>YARD</b>	7YATO	T-SHIRT / T-SHIRT	<b>86</b>
<b>YARD</b>	7YATY	T-SHIRT / T-SHIRT	<b>86</b>
<b>YARD</b>	7YAVO	T-SHIRT / T-SHIRT	<b>86</b>
<b>YARD</b>	7YAVY	T-SHIRT / T-SHIRT	<b>86</b>
<b>YARD</b>	7YGMO	GILET / VEST	<b>90</b>
<b>YARD</b>	7YGMY	GILET / VEST	<b>90</b>
<b>YORU</b>	5YOR160	GILET / BODYWARMER	<b>59</b>
<b>YORU</b>	5YOR170	GILET / BODYWARMER	<b>59</b>

## ACCESSOIRES / ACCESSORIES

<b>ARMYARD</b>	7ARMG	BRASSARD / ARMBAND	<b>114</b>
<b>ARMYARD</b>	7ARMO	BRASSARD / ARMBAND	<b>114</b>
<b>ARMYARD</b>	7ARMY	BRASSARD / ARMBAND	<b>114</b>
<b>ATEX</b>	MO71900	ACCESSOIRES / ACCESSORIES	<b>117</b>
<b>ATEX</b>	MO71910	ACCESSOIRES / ACCESSORIES	<b>117</b>
<b>BARRICADE TAPE</b>	MO70010	RUBAN / TAPE	<b>115</b>
<b>HEADLIGHT LED</b>	MO71920	ACCESSOIRES / ACCESSORIES	<b>116</b>
<b>HEADLIGHT LED</b>	MO71950	ACCESSOIRES / ACCESSORIES	<b>116</b>
<b>KOUKOU</b>	5KOU16	BRASSARD / ARMBAND	<b>114</b>
<b>TRAFFIC CONE</b>	70300	SIGNALISATION / SIGNAGE	<b>115</b>
<b>TRAFFIC CONE</b>	70303	SIGNALISATION / SIGNAGE	<b>115</b>



# NOTES

---

---

---

---

---

---

---

---

---

---

---

---

---

---

---

---

---

---

---

---

---

---

---

---

---

---

---

---

---

---





**Concepteur & fournisseur d'équipements  
de protection individuelle de la tête aux pieds**

Designer and supplier of personal protective  
equipments from head to toe

555 rue de la Dombes  
01700 MIRIBEL – France

T +33 (0)4 72 26 23 23  
F +33 (0)4 72 26 23 20

[contact@coverguard-safety.com](mailto:contact@coverguard-safety.com)

---

**[coverguard-safety.com](http://coverguard-safety.com)**



**SAFETY DESIGNER**